

Guidelines for riparian fencing in flood-prone areas



Acknowledgements

The Department of Environment, Land, Water and Planning (DELWP) developed these guidelines through a collective effort with many organisations and individuals. In particular, the department thanks:

- Greg Peters and Simone Wilkie (Riverness Pty Ltd) for developing the guidelines
- the Project Working Group, comprising Peter Vollebergh (Waterway Health, DELWP, Project Manager); Anthony Wilson (North East Catchment Management Authority); Peter Sacco and Steve Martin (then North East Catchment Management Authority); Andrew McDougall (Parks Victoria); Lang Dowdell (North Central Catchment Management Authority); Glen Merrick (then North Central Catchment Management Authority); Luke Austin (Wimmera Catchment Management Authority); David Nichols (Glenelg Hopkins Catchment Management Authority); and Les Tate (Waterway Health, DELWP)
- catchment management authority staff members, who responded to surveys, provided advice, assisted with field visits, provided comments on draft reports and provided photos
- Dr. James Grove, who developed the approach to identifying floodplain types and provided information and advice about fencing options for various floodplain types
- Nathan Vincent (Nathan Vincent Fencing), who provided cost estimates and advice for various fencing options
- Assoc. Prof. Ian Rutherford (University of Melbourne), who assisted at several stages of development of the guidelines—especially with refining Table 3.1—and provided photos of floodplain types.

Riverness Pty Ltd provided photos that are not specifically credited, except in Section 3.2.1 where Assoc. Prof. Ian Rutherford (University of Melbourne) provided the photos.

© The State of Victoria Department of Environment, Land, Water & Planning 2015



This work is licensed under a [Creative Commons Attribution 4.0 International licence](http://creativecommons.org/licenses/by/4.0/). You are free to re-use the work under that licence, on the condition that you credit the State of Victoria as author. The licence does not apply to any images, photographs or branding, including the Victorian Coat of Arms, the Victorian Government logo and the Department of Environment, Land, Water and Planning (DELWP) logo. To view a copy of this licence, visit <http://creativecommons.org/licenses/by/4.0/>

Preferred way to cite this publication

Department of Environment, Land, Water and Planning 2015. *Guidelines for riparian fencing in flood-prone areas*. East Melbourne, Victoria.

ISBN 978-1-74146-294-4 (pdf)

Accessibility

If you would like to receive this publication in an alternative format, please telephone the DELWP Customer Service Centre on 136186, email customer.service@delwp.vic.gov.au, or via the National Relay Service on 133 677 www.relayservice.com.au. This document is also available on the internet at www.delwp.vic.gov.au

Disclaimer

This publication may be of assistance to you but the State of Victoria and its employees do not guarantee that the publication is without flaw of any kind or is wholly appropriate for your particular purposes and therefore disclaims all liability for any error, loss or other consequence which may arise from you relying on any information in this publication.

Front cover: Glenelg River. Photo courtesy: Glenelg Hopkins Catchment Management Authority

Contents

1	Introduction	3
1.1	Fencing in flood-prone areas	3
1.2	Purpose of the guidelines	5
1.3	How the guidelines were developed	5
2	Steps in floodplain fencing design	6
3	Identifying the floodplain type for the project site	8
3.1	Defining the floodplain	8
3.2	Identifying floodplain types	8
3.2.1	Floodplain key	9
3.2.2	Advice about using the floodplain key	17
4	Choosing fencing option(s) for the floodplain type	19
4.1	A1 – Confined coarse-textured floodplain	19
4.2	A3 – Unconfined vertical-accretion sandy floodplain	19
4.3	A4 – Cut-and-fill floodplain	19
4.4	B3 – Meandering river lateral-migration floodplain	20
4.5	C1, C2 – Low-energy vertical-accretion floodplain	21
4.6	Summary	21
5	Avoiding flood damage	22
5.1	Reducing the likelihood fences will encounter floods	22
5.2	Implementing alternatives to conventional fencing	23
5.2.1	Virtual fencing	23
5.2.2	No fencing	24
6	Making fences more resistant to flood damage	25
6.1	Aligning fences in relation to flood flows	25
6.2	Strengthening strainer (end) assemblies	26
6.2.1	Design considerations	26
6.2.2	Construction considerations	28
6.3	Strengthening in-line posts	29
6.3.1	Post types	29
6.3.2	Post depth	31
6.3.3	Post spacings	31

6.4	Other design options	31
6.4.1	Fencing wire	31
6.4.2	Fence height	34
6.4.3	Location of gates	35
7	Making fences more resilient to flood damage	36
7.1	Installing a collapsible fence	36
7.1.1	Drop-down fence	36
	Case study: Drop-down fence at Tullaroop Creek, north-central Victoria	40
7.1.2	Lay-down fence	41
7.2	Installing a sacrificial fence	41
7.2.1	Full-length sacrificial fence	41
	Case study: Lay-down fence at Glenelg River, Warrock, south-west Victoria	42
7.2.2	High-risk sacrificial fence	44
7.3	Minimising fences crossing waterways	44
7.3.1	Alternatives to fences	44
	Case study: Sacrificial fence, Black Range Creek, north-east Victoria	46
8	References	47
	Appendix A: What is a floodplain?	49
A1	Flood risk	49
A2	Ecological processes	50
A3	Ecosystem structures	50
A3.1	Floodplain features	50
A3.2	Floodplain soils	52
A3.3	Floodplain vegetation	52
A3.4	Floodplain habitats	52

1 Introduction

1.1 Fencing in flood-prone areas

As part of the Victorian Government's Waterway Management Program, there is substantial investment in riparian improvement and maintenance projects by catchment management authorities (CMAs). The projects involve working collaboratively with landholders, including Crown frontage licensees, to undertake works such as fencing, revegetation, weed management and the provision of infrastructure to support off-stream livestock watering.

As shown in figures 1.1, 1.2 and 1.3, floods in Victoria in 2010, 2011 and 2012 caused significant damage to riparian fences. This has raised issues about the type, design, construction and location of fences on active floodplains, and about the usefulness of funding riparian works such as fencing on floodplains that can be damaged during floods.



Figure 1.1 – Concrete end assembly damaged by 2012 flood, tributary of the Six Mile Creek, Baringhup, north-central Victoria (photo: North Central CMA)



Figure 1.2 – Extensive debris build-up, Richardson River, Marnoo West, north-central Victoria
(photo: North Central CMA)



Figure 1.3 – Riparian fence damaged by 2011 flood, Wimmera River *(photo: Wimmera CMA)*

1.2 Purpose of the guidelines

These guidelines are intended to help CMAs and other managers of riparian areas choose the best techniques for siting, designing and constructing fences in flood-prone areas. This will help ensure that the maximum benefit is gained from the significant government and private resources applied to riparian fencing.

This report details:

- steps in floodplain fencing design (Section 2)
- identifying the floodplain type (Section 3)
- choosing the most appropriate fencing options for the floodplain type (Section 4)
- avoiding flood damage (Section 5)
- making fences more resistant to flood damage (Section 6)
- making fences more resilient to flood damage (Section 7).

1.3 How the guidelines were developed

In 2012, the (then) Department of Sustainability and Environment commissioned Riverness Pty Ltd to develop these guidelines. The project had three stages:

- a literature review, to review approaches to fencing on active floodplains and the applicability of techniques in the literature to Victorian conditions (detailed in *Literature review and discussion paper for fencing in flood-prone areas*, Riverness Pty Ltd, 2013a)
- a post-flood review, comprising an online survey of CMAs and other riparian land managers about the techniques they use to site and construct fences in flood-prone areas, followed by interviews with key respondents and regional visits to discuss particular sites and techniques and focusing on successes and failures during flood events in 2010, 2011 and 2012 (detailed in *Guidelines for riparian fencing in flood-prone areas - post flood review findings and recommendations*, Riverness Pty Ltd, 2013b)
- development of these guidelines, based on the findings and recommendations of the two earlier stages.

2 Steps in floodplain fencing design

It is not possible to design a fence that will withstand the force of a major flood (Staton and O'Sullivan 2006). Therefore, these guidelines have been developed to reduce and, where possible, minimise the risks and costs of flood damage to fences, using the following three-step process (see Figure 2.1).

1. Identify the floodplain type for the project site (see Section 3).
2. Choose the most appropriate fencing option(s) for the floodplain type (see Section 4).
3. Consider the guidelines for each option/s chosen, according to the aim of:
 - avoiding flood damage (see Section 5), best achieved by:
 - reducing the likelihood fences will encounter floods (by appropriate location on the floodplain, for example on higher, drier ridges or outside the floodplain), or
 - implementing alternatives to conventional fencing (such as virtual fencing or no fencing), to control livestock on the floodplain
 - making fences more resistant to flood damage (refer to Section 6), best achieved by:
 - aligning fences in relation (and preferably parallel) to the flood flow
 - strengthening end assemblies (to maintain good wire tension)
 - strengthening in-line posts (to resist overturning)
 - considering other design options
 - making fences more resilient to flood damage (refer to Section 7), best achieved by:
 - installing collapsible fences
 - installing sacrificial fences
 - minimising the number of fences across waterways.

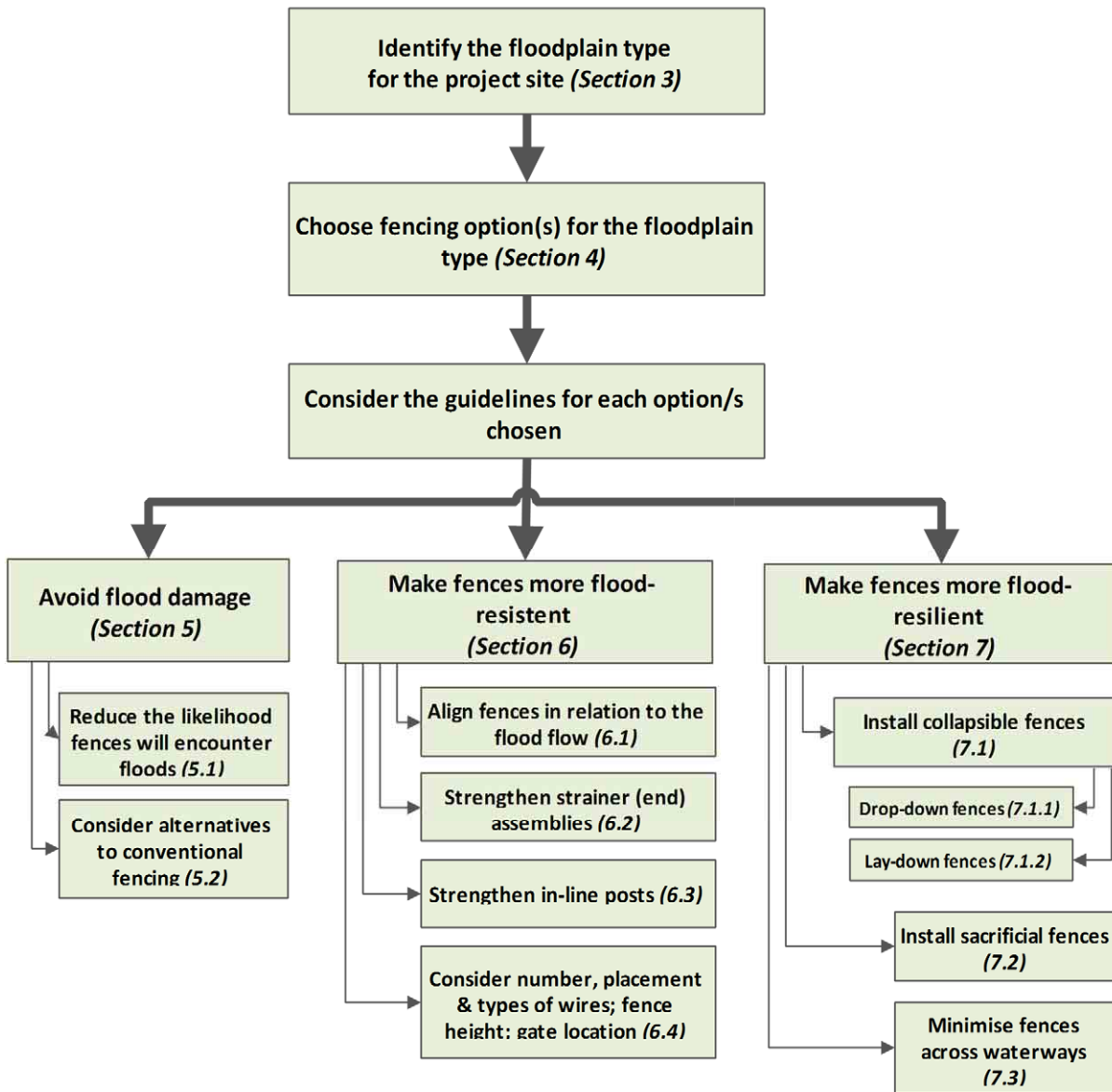

Figure 2.1 – Steps in floodplain fencing design

3 Identifying the floodplain type for the project site

3.1 Defining the floodplain

Approaches to defining a floodplain are generally based on flood risk, ecological processes or ecosystem structures. Appendix A describes these approaches.

In these guidelines:

- a *floodplain* is the area of land adjacent to a waterway subject to inundation by the probable maximum flood¹.
- a *flood-prone area* is the channel, stream and portion of the floodplain that conveys the main flow of floodwater. A flood-prone area is often, but not necessarily, the area of deeper flow, or the area where higher velocity occurs.

3.2 Identifying floodplain types

Nanson and Croke (1992) used the planform (shown in Figure 3.1), the available energy (gauged using specific stream power - ω) and the sedimentology of floodplains to distinguish different types of floodplains. This approach yields three types, on the basis of their energy:

- high-energy, non-cohesive floodplains ($\omega \geq 300 \text{ W m}^{-2}$): these are disequilibrium floodplains that erode in response to extreme events and are typically located in steep headwater areas where valley confinement prevents channel migration
- medium-energy, non-cohesive floodplains ($\omega = 10 - 300 \text{ W m}^{-2}$): these are equilibrium floodplains formed by regular flow events in relatively unconfined valleys
- low-energy, cohesive floodplains ($\omega \leq 10 \text{ W m}^{-2}$): these are floodplains formed by regular flow events along laterally stable, single-thread or anastomosing low-gradient channels.

¹ A probable maximum flood is the largest flood that could conceivably occur at a particular location. Generally, it is not physically or financially possible to provide protection against such a flood.

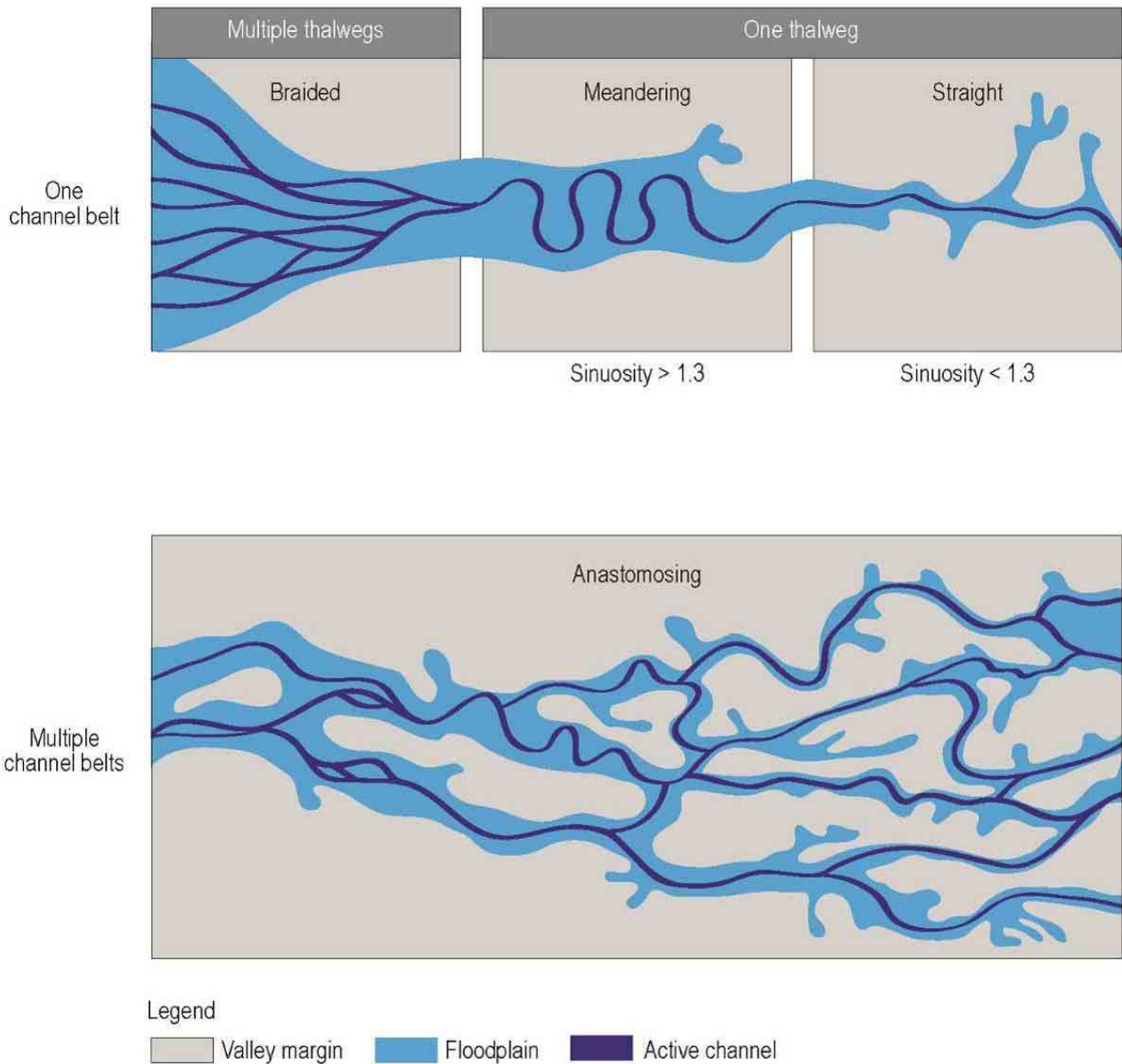

Figure 3.1 – Examples of different river planforms (from a proposed classification in Makaske 2001)

3.2.1 Floodplain key

The floodplain types in Table 3.1 are taken from those described by Nanson and Croke (1992). Six of these are particularly relevant for Victoria.

Figure 3.2 is a key to help you identify the type of floodplain at your project site. Answering each question in turn will identify your type of floodplain, or take you to another question.

Section 3.2.2 has advice about using the floodplain key.

Table 3.1 – A classification of floodplains

State/ Substate	Type	Stream power	Sediment	Erosional/ depositional processes	Landforms	Channel planform	Environment	Where in Victoria
A1	Confined coarse-textured floodplain	>1000	Poorly sorted boulders and gravel; buried soils	Catastrophic floodplain erosion and overbank vertical accretion; abandoned-channel accretion; minor lateral accretion	Boulder levees and gravel spays; back channels; abandoned channels and scour holes	Single-thread straight / irregular	Steep upland headwater valleys	Restricted to the upper valleys of rivers in the north-east and East Gippsland (see Figure 3.3) Examples: Upper cleared reaches of the Wonnangatta, Kiewa East and West branches, and the Upper Snowy River
A2	Confined vertical-accretion floodplain	300-1000	Basal gravels and abundant sand with silty overburden	Catastrophic floodplain erosion and overbank vertical accretion	Large levees and deep back channels and scour holes	Single-thread straight / irregular	Upland headwater valleys	Not found in Victoria
A3	Unconfined vertical-accretion sandy floodplain	300-600	Sandy strata interbedded muds	Catastrophic channel widening; overbank vertical accretion; island deposition & abandoned-channel accretion; minor lateral accretion	Flat floodplain surface	Single-thread meandering	Semi-arid open valleys	Rare in Victoria Example: Bet Bet Creek
A4	Cut-and-fill floodplain	~300	Sands, silts and organics	Catastrophic gullying, overbank vertical accretion; abandoned-channel accretion	Flat floodplain surface; channel fills; swampy meadows	Straight / irregular	Upland dells and semi-arid alluvial filled valleys	Common in the steep, cleared floodplains of small- to medium-sized streams throughout the state. Floodplains tend to be narrow (hundreds of metres wide rather than kilometres). Streams in these floodplains can be deeply eroded. Most catchments in Victoria have examples. See figures 3.4 and 3.5
B1	Braided river floodplain	50-300	Gravels, sand and occasional silt.	Braid-channel accretion; overbank vertical accretion; minor lateral and abandoned-channel accretion	Undulating floodplain of abandoned channels and bars; backswamps	Braided	Abundant sediment load in tectonically and/or glacially active areas	Not found in Victoria
B2	Wandering gravel-bed river floodplain	20-200(?)	Gravels, sands, silts and organics	As for braided and meandering channels	Abandoned channels; sloughs; braid-bars; islands; back channels	Braided, meandering and anastomosing	Abundant sediment alternating sedimentation zones in tectonically and/or glacially active areas	Not found in Victoria

State/ Substate	Type	Stream power	Sediment	Erosional/ depositional processes	Landforms	Channel platform	Environment	Where in Victoria
B3	Meandering river lateral- migration floodplain	10-60	Gravels, sands and silts	Cut-bank erosion; lateral point-bar accretion; overbank vertical and abandoned-channel accretion; counterpoint accretion; minor oblique accretion	Flat-to-undulating floodplain surface; oxbows; backswamps	Meandering	Usually middle-to- lower valley reaches	The most common stream type in the middle reaches of Victorian rivers. These floodplains also have anabranches. In Victoria these often grade downstream into floodplain type C2 Examples: middle Kiewa River, River Murray, lower Goulburn River, lower Ovens River and Latrobe River (see figures 3.6, 3.7 and 3.8)
C1	Laterally stable, single- channel floodplain	<10	Abundant silts and clays with organics	Overbank vertical accretion	Flat floodplains with low levees; backswamps	Single-thread straight / meandering	Abundant fine sediment load middle-lower reaches	Typical of the floodplains in the north-west of the state Examples: Avoca River, mid Loddon River (see Figure 3.9) and Wimmera River
C2	Anastomosing g river floodplain	<10	Gravel and sands with abundant silts and clays	Overbank vertical accretion; island deposition	Flat floodplains with extensive levees, islands and flood- basins; crevasse- channels and splays.	Anastomosing	Very low gradient with wide floodplains	Found in downstream or middle reaches of rivers in north of Victoria and in Gippsland Examples: lower Thomson (see Figure 3.10), Latrobe, Macalister, King and Ovens rivers (see Figure 3.11).
C2a	Anastomosing g river, organic rich floodplains\	<10	As for C2 with abundant organics and lacustrine deposits	As for C2 with peat formation and lacustrine sedimentation	As for C2 with lakes and peat swamps	Anastomosing	As for C2 in humid environments	Not found in Victoria
C2b	Anastomosing g river, inorganic floodplain	<10	As for C2 but with little or no organics	As for C2	As for C2	Anastomosing channels	As for C2 in semi-arid environments	Typical of floodplains in the north-west of Victoria Examples: lower Loddon (see Figure 3.12), Avoca and Wimmera rivers

Note: this table is based on Nanson and Croke (1992).

No.	Question / response	Floodplain
1	Where is the project site? a. Upper reaches b. Middle-to-lower reaches	<i>(Go to 5)</i> <i>(Go to 2)</i>
2	Is the channel anastomosing (multiple channels, anabranches)? a. Yes b. No	C2 <i>(Go to 3)</i>
3	Is the dominant riverbank sediment silt or clay? a. Yes b. No	C1 <i>(Go to 4)</i>
4	What is the sinuosity of the stream? a. Less than 1.3 b. Greater than 1.3	B3 <i>(Go to 5)</i>
5	Does the stream abut the hill slope for greater than 90% of its length? a. Yes b. No	A1 <i>(Go to 6)</i>
6	Is the stream in a fairly narrow valley, and can you describe it as a swampy meadow? a. Yes b. No	A4 A3

Figure 3.2 – Key to identifying floodplain types



Figure 3.3 – Floodplain type A1 – upper Macalister River, Gippsland



Figure 3.4 – Floodplain type A4 – upper Wimmera River

Figure 3.5 – Floodplain type A4 – Flynn's Creek, Latrobe catchment, Gippsland



Figure 3.6 – Floodplain type B3 – Broken Creek (photo: Google Earth)



Figure 3.7 – Floodplain type B3 – Lower Owens River, Peechalba (photo: Google Earth)

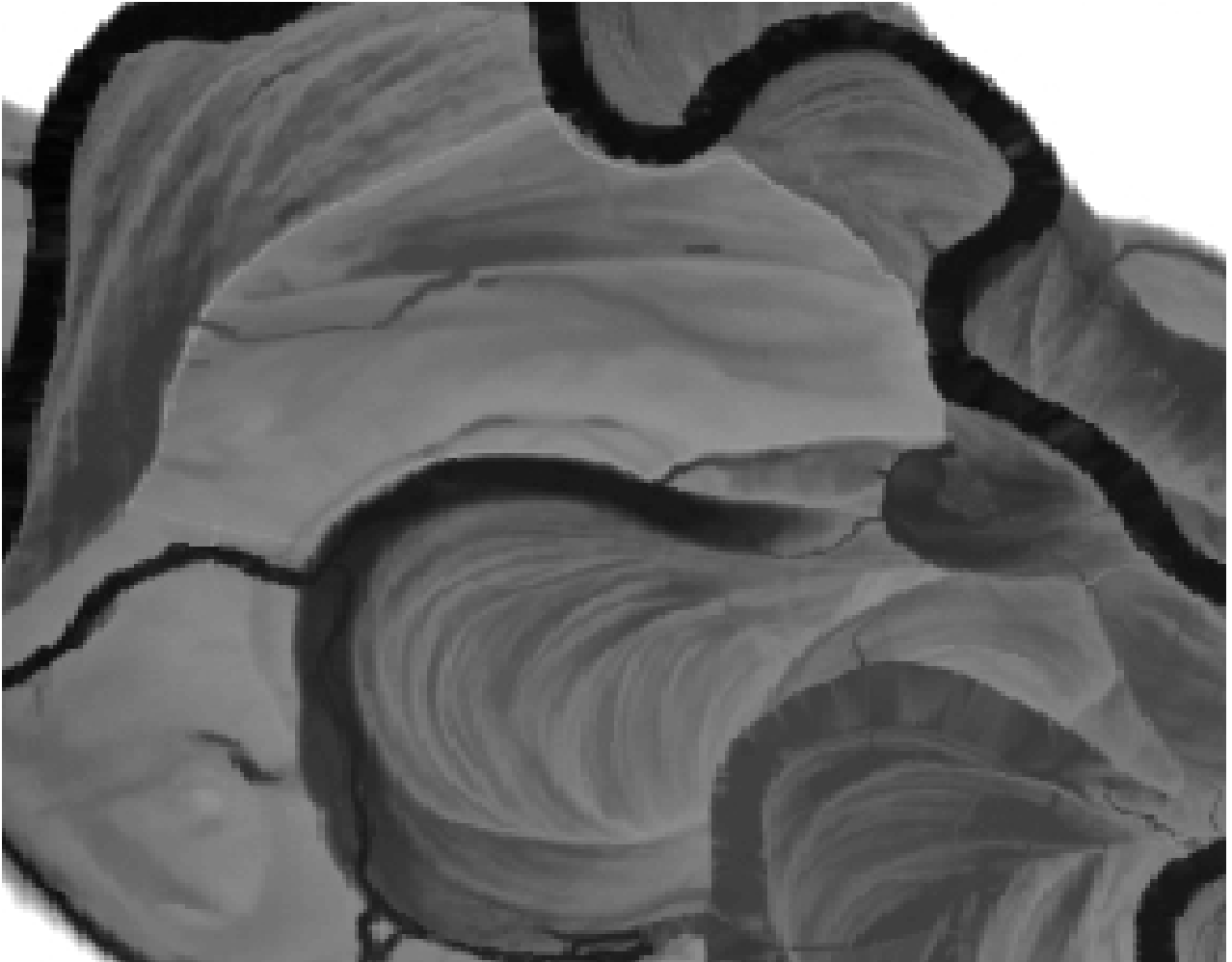

Figure 3.8 – Floodplain type B3 – Murray River, LiDAR image showing scroll bars



Figure 3.9 – Floodplain type C1 – mid Loddon River

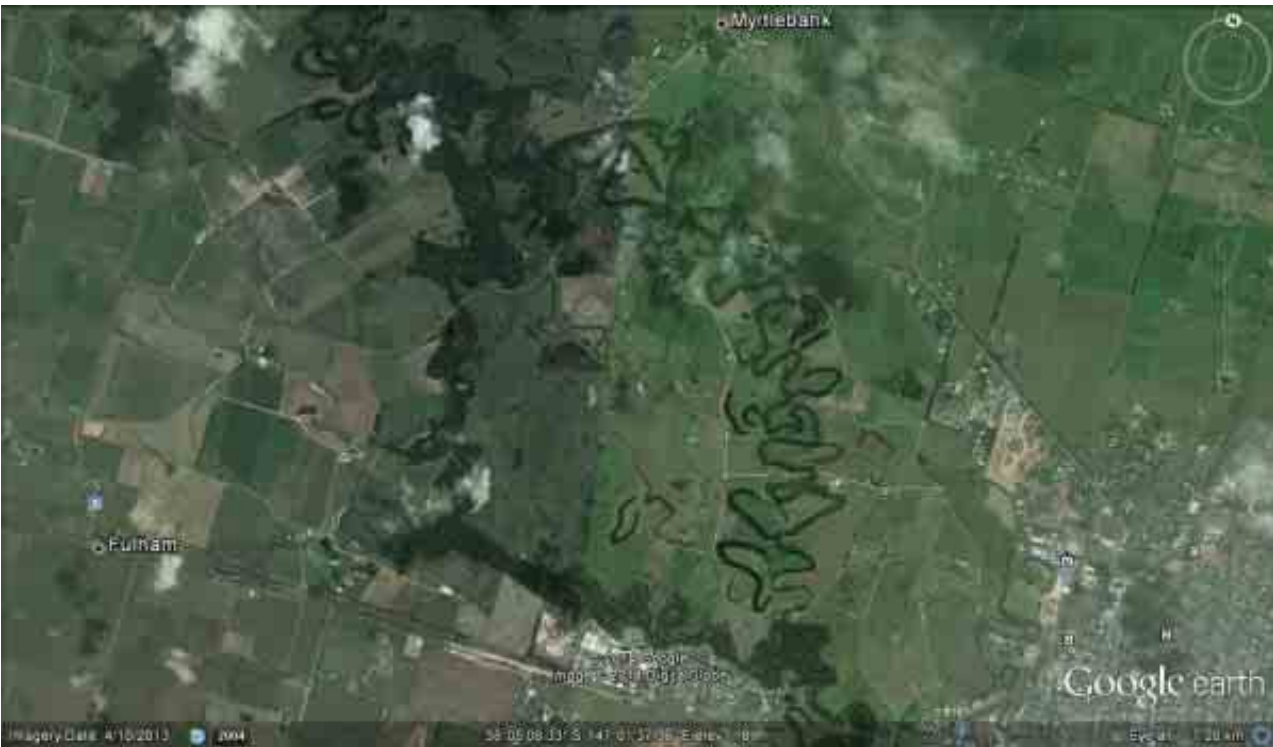

Figure 3.10 – Floodplain type C2 – Thompson River, near Sale, Gippsland (photo: Google Earth)



Figure 3.11 – Floodplain type C2 – junction of the Ovens and King rivers, north-east Victoria (photo: Google Earth)



Figure 3.12 – Floodplain type C2b – lower Loddon River in minor flood, showing multiple channels

3.2.2 Advice about using the floodplain key

Use the information in this section when answering the questions in Figure 3.2 – Key to identifying floodplain types.

Question 1 – Where is the project site?

In its upper reaches, the river hits the valley sides in places, as figures 3.13 and 3.14 show. It does not have an extensive floodplain, like it may in the middle-to-lower reaches, as Figure 3.15 shows.

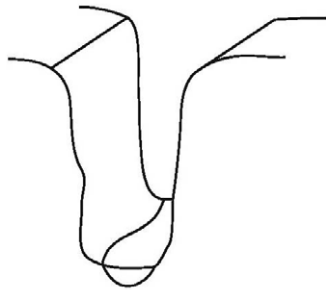

Figure 3.13 – Upper reaches (gorge)
(modified from Sear et al. 2003)

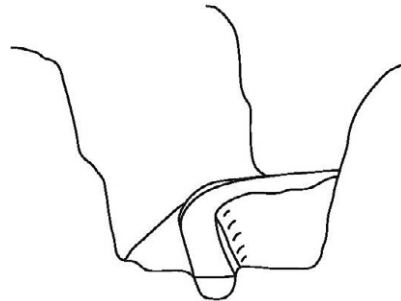

Figure 3.14 – Upper reaches (confined channel / floodplain)
(modified from Sear et al. 2003)

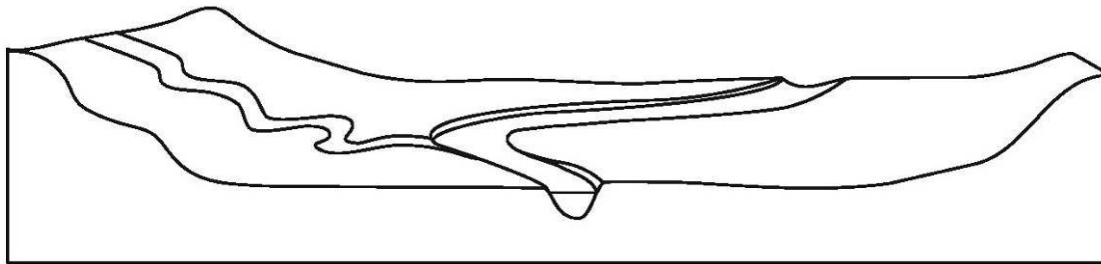

Figure 3.15 – Middle-to-lower reaches (unconfined channel / floodplain)
(modified from Sear et al. 2003)

Question 2 – Is the channel anastomosing?

A channel is anastomosing or braided (as Figure 3.1 shows) if the river flow at bankfull, or lower, divides into multiple channels.

Question 3 – Is the dominant riverbank sediment silt or clay?

Sediments with a high content of silt and clay will, when mixed with enough water to make a firm dough, roll into a thin roll. If there is a high clay content, you can bend the roll into a curve without breaking it.

If the bank is made of the same (or similar) sediment, assess the whole bank. If the bank is made of multiple layers of different sediment sizes, choose the dominant sediment size for the assessment.

Question 4 – What is the sinuosity of the stream?

You calculate the sinuosity of the stream at the desktop, using current 1:25,000 mapping or data from a geographic information system (GIS). Divide the stream length (defined as the curvilinear distance measurement along the centre of the channel between two points) by the straight-line distance down the valley between the same two points.

The two points are at the upstream and downstream extents of the project site if it includes three meander bends, or around 30 times the channel width. If your project site does not include three meander bends or is shorter than 30 times the channel width, extend your measurement to one of these lengths.

Figure 3.1 shows examples of sinuosity greater than, and less than, 1.3.

Question 5 – Does the stream abut the hill slope for greater than 90% of its length?

For the same length you used to calculate sinuosity in Q. 4, work out the percentage of the channel that is in contact with the hill slope, using 1:25,000 mapping.

As Figure 3.16 shows, a confined valley should have access to the floodplain for less than 10 % of the reach length.

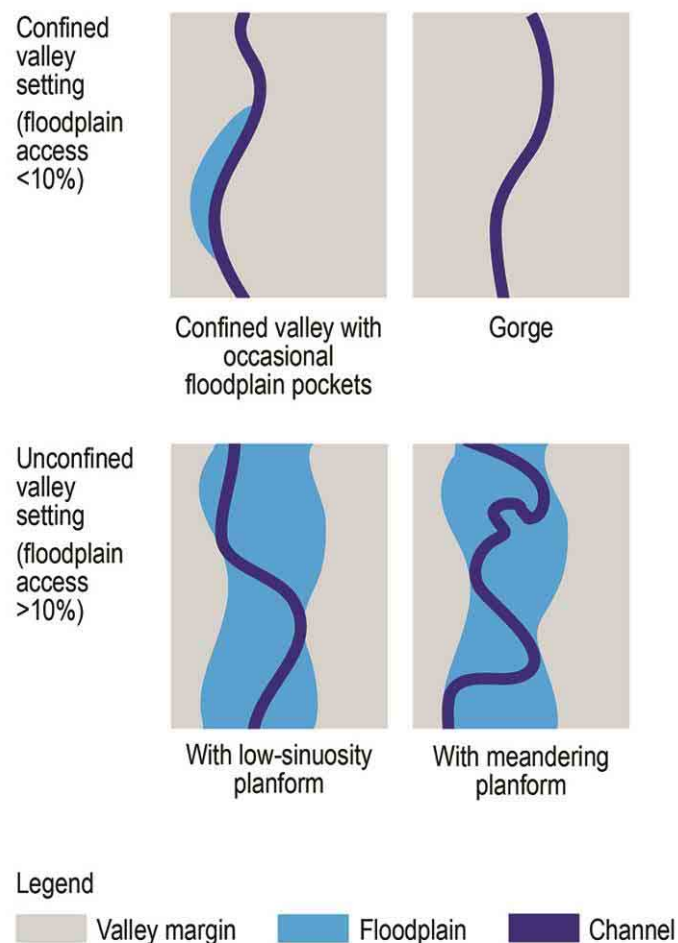

Figure 3.16 – River channels in confined and unconfined valleys, showing the percentage of contact with hill slopes and floodplains (modified from Brierley et al. 2002)

Question 6 – Is the stream in a fairly narrow valley, and can you describe it as a swampy meadow?

To identify the relevant ecological vegetation class (EVC) for the project site:

- locate the geographical area of interest, using DELWP’s Biodiversity Interactive Map²
- identify the bioregion and EVC for the area of interest by:
 - changing the map scale to 1:100,000
 - in the Map Layers panel, clicking on the Vegetation folder, then the Ecological Vegetation Classes folder
 - ticking '1750 EVCs' and the adjacent information icon 'i'
 - clicking Refresh Map (the map will now display the 1750 EVCs map layer)
 - clicking on an area of interest
 - in the Identify Results panel, read off the EVC name and EVC number³

If the EVC is Freshwater Meadow and is number 124, 125, 281, 767 or 959, and is a narrow upland valley, then the project site is likely to be a swampy meadow.

² <http://mapshare2.dse.vic.gov.au/MapShare2EXT/imf.jsp?site=bim>

³ Some project sites may contain more than one EVC and/or be a transitional zone (ecotone) between EVCs.

4 Choosing fencing option(s) for the floodplain type

This section helps you choose one or more fencing options for your project site, based on the floodplain type you identified in Section 3.

4.1 A1 – Confined coarse-textured floodplain

This type of floodplain is likely to be a zone of high sediment and debris deposition. As such, there is a high possibility of a fence being damaged or lost.

Preferably, avoid flood damage using the options in Section 5.

However, if you can locate a fence behind the floodplain levee, making the fence more resistant to flood damage—using the techniques in Section 6—may be an option. This will not be feasible if the floodplain is in a gorge.

4.2 A3 – Unconfined vertical-accretion sandy floodplain

This type of floodplain aligns with high-energy ephemeral channels. There is a high likelihood a fence on this type of floodplain will be destroyed (by erosion, debris build-up and/or deposition) during flash flood events.

As Figure 4.1 shows, the key issue is whether you can locate the fence well away from the channel.

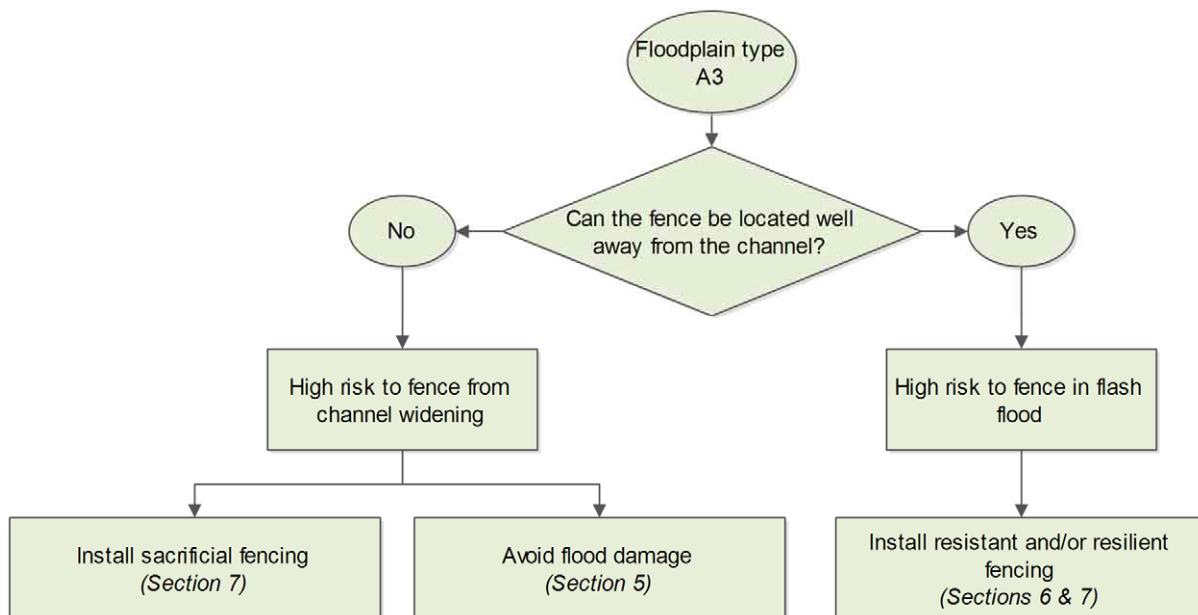

Figure 4.1 – Fencing options for unconfined vertical-accretion sandy floodplains

4.3 A4 – Cut-and-fill floodplain

This type of floodplain is typically described as a swampy meadow. The potential for gullying is often high, making fencing problematic. Also, it is highly likely that a flood will destroy a fence.

The preference is to avoid flood damage using the options in Section 5. Alternatively, fencing well back from the channel edge with a well-vegetated riparian buffer could be possible.

4.4 B3 – Meandering river lateral-migration floodplain

This type of floodplain is likely to be inundated frequently, unless incision has taken place.

As Figure 4.2 shows, the key issue is whether you can install the fence parallel to the flood flow. As the channel is also likely to migrate laterally, running a fence parallel to flood flows will help prolong its life.

You also need to take care to ensure the top of the point bar matches bankfull on the opposite bank, so the fence is outside the channel.

While this type of floodplain is relatively low-energy compared to the channel, any topographical variation (such as flood runners, including gutters and gullies) will increase the flow velocity. In these instances, sacrificial fences (explained in Section 7) may be appropriate.

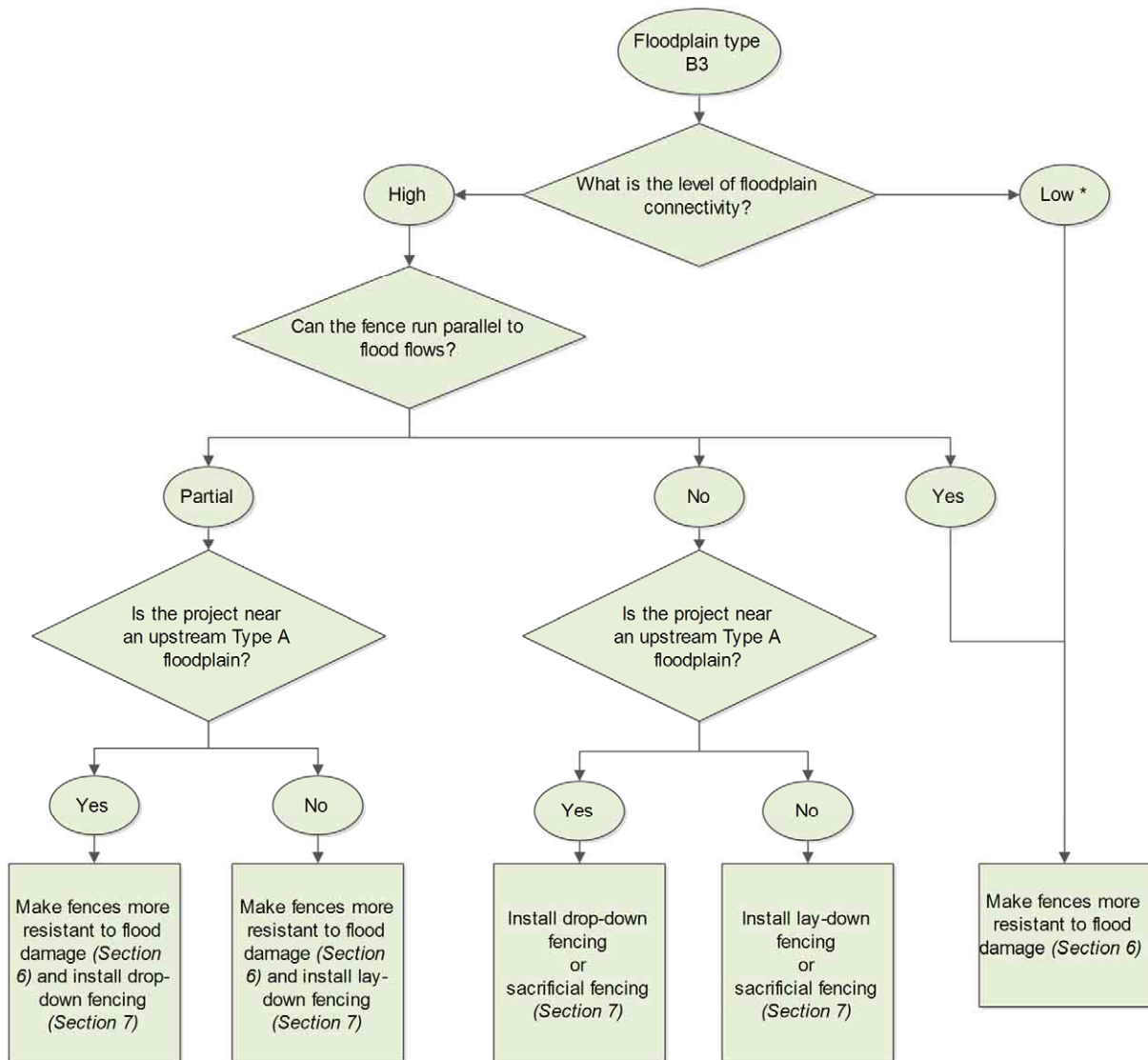

*Low floodplain connectivity – flood events $\geq 10\%$ AEP cannot enter the floodplain

Figure 4.2 – Fencing options for meandering river lateral-migration floodplain

4.5 C1, C2 – Low-energy vertical-accretion floodplain

These types of floodplain are low-energy. However, to minimise damage, you should preferably make a fence more resistant to flood damage, using the techniques in Section 6.

Where possible, position a fence behind the floodplain levee.

4.6 Summary

State/ substate	Floodplain	Preferred fencing option		
	Type	Avoidance	Resistance	Resilience
A1	Confined coarse-textured floodplain	✓		
A3	Unconfined vertical-accretion sandy floodplain	✓	✓	✓
A4	Cut-and-fill floodplain	✓	✓	✓
B3	Meandering river lateral migration floodplain		✓	✓
C1, C2	Low-energy cohesive floodplain		✓	

5 Avoiding flood damage

You can avoid flood damage to a fence by:

- avoiding floods: reducing the likelihood that the fence will encounter a flood by locating it appropriately on the floodplain
- avoiding using a fence: using virtual fencing or no fencing.

5.1 Reducing the likelihood fences will encounter floods

To minimise the risk of flood damage, you should locate the fence:

- well back from the main stream channel and flood-prone areas (unlike the example in Figure 5.1)
- parallel to the anticipated direction of the flood flow
- outside the line of most floods (for example, outside the 10% AEP⁴ flood zone)
- as far up-slope as possible.



Figure 5.1 – What can happen to a riparian fence when it's located too close to the channel, Jeremal Creek (north-east Victoria) after the 2012 flood (photo: North East CMA)

⁴ AEP - annual exceedance probability, which is the statistical likelihood of a flood of a given size or larger occurring in any one year, usually expressed as a percentage.

When deciding where to locate a fence, you should consider:

- landform and land type (which you can use as a guide for location)
- flood frequency
- stream power.

While avoiding floods reduces maintenance costs and prolongs the life of a fence, locating a fence to avoid a flood can create a large river paddock which the landholder may consider untenable. However, they might consider using such a paddock for:

- cropping (outside the immediate riparian land)
- controlled grazing (for example, for drought fodder or summer feed)
- cell grazing (using electric fencing and solar units) to break it into smaller, manageable cells.

5.2 Implementing alternatives to conventional fencing

If livestock graze the area adjoining a waterway, some form of fencing is normally required to manage their access. However, access can also be managed by virtual fencing or by other options which do not involve fencing.

5.2.1 Virtual fencing

The aim of virtual fencing is the welfare-friendly confinement of grazing livestock with boundaries identified by global positioning system (GPS) points. The fence only exists as lines on a computer, without wires or fixed transmitters (CSIRO 2011).

Virtual fencing uses the same principles as electric fencing, except there is no physical fence. Rather, there is a wireless sensor network comprising microcomputers, radios and sensors, some of which are fitted into livestock neck collars (as Figure 5.2 shows). A collar emits a sound when the livestock wearing it approaches the virtual fence. If the livestock ignores the sound warning and crosses the virtual fence, it gets a mild electric shock⁵—around one-fifth of the voltage of a conventional electric fence—and learns to avoid the virtual fence. The sound and shock both stop if the livestock moves past the virtual fence, but occur again when the livestock stops moving, to encourage it to move out of the fenced area (CSIRO 2011). Livestock quickly learn to avoid the virtual fence.



Figure 5.2 – Cows wearing neck collars in a virtual fencing situation (photo: Filmer 2007)

⁵ Research overseen by an independent animal welfare expert found that livestock aren't unduly stressed by the virtual fence.

The CSIRO has developed a prototype virtual fencing system and successfully used it with a herd of cattle. However, the prototype system is not yet robust enough to make it commercially viable (Filmer 2007, CSIRO 2011).

At the time of publishing these guidelines, Victorian legislation did not allow the use of virtual fencing for livestock management.

5.2.2 No fencing

In some situations, it may not be practical to install a fence on a floodplain. In these situations, options for managing livestock include:

- implementing a controlled livestock grazing regime⁶
- providing troughs with clean water, away from the waterway (as shown in Figure 5.3)
- providing shade and shelter away from the waterway
- providing crossings in areas where livestock naturally cross water (as shown in Figure 5.4).

You should entertain these options only after assessing all other fencing options.



Figure 5.3 – Livestock watering well away from riparian areas (photo: Glenelg Hopkins CMA)



Figure 5.4 – Controlled livestock crossing (photo: Glenelg Hopkins CMA)

⁶ For more information, see Department of Environment and Primary Industries (2013). *Managing grazing on riparian land. Decision support tool and guidelines*. East Melbourne, Victoria.

6 Making fences more resistant to flood damage

When you cannot avoid locating a fence in a flood-prone area, and alternatives to conventional fencing aren't possible or acceptable, the next step is to determine if you can design your fence to:

- minimise the likelihood of damage during a flood event (by designing the fence to withstand the flood's impact)
- maintain the fence's function post-flood, with minimal repairs.

This type of fence design is known as flood-resistant fencing.

Typically, the degree to which a fence can survive floods, particularly when floodwaters are laden with debris, will depend on:

- the fence's alignment in relation to flood flows
- the strength of the strainer (end) assemblies
- the strength of in-line posts (to resist overturning)
- resistance to floodwaters.

6.1 Aligning fences in relation to flood flows

To minimise the impact of floodwaters and associated flood debris on a fence, you should align it as close as practicable to the floodwater flow path (as shown in figures 6.1 and 6.2).

In general, you should install a fence considering the contours of the floodplain. Align the fence no greater than 45° to the floodwater flow path. As the risk of flooding increases, you should align a fence nearer-to-parallel to the floodwater flow path.

The more parallel a fence is to the direction of the floodwater flow path, the less likely it is to be damaged. Also, this means a fence is straighter, which makes it cheaper and simpler to install.



Figure 6.1 – Fencing aligned to flood flows (photo: Glenelg Hopkins CMA)



Figure 6.2 – Fencing aligned to flood flows (photo: Glenelg Hopkins CMA)

6.2 Strengthening strainer (end) assemblies

During floods, debris can place additional tension on a fence. Many kilometres of fencing can be damaged or lost if end assemblies fail (Wallace 2011).

Strainer (end) assemblies are the most important and expensive (NECMA 2009) part of a fence. Their job is to carry the strain of the fencing wire, impact from livestock, and the weight of accessories such as gates (DAFWA 2011, OneSteel 2012). If a strainer assembly fails, the whole fence can fail (Waters and Rivers Commission 2000, Staton and O'Sullivan 2006, OneSteel 2012).

It is therefore essential that strainer assemblies in flood-prone areas are as strong as possible, to:

- take the increased pressures placed on the fence
- provide an immovable anchorage
- maintain wire tension (to promote vibration, which helps minimise debris loads).

6.2.1 Design considerations

The key things to consider when designing a strainer assembly in a flood-prone area are its:

- type
- material
- cost.

Type

There are two main strainer assembly designs:

- diagonal stay: most suited to heavy, dense soil conditions (DAFWA 2011)
- box: most suited to situations where additional strength is required, for example in sandy or boggy conditions (DAFWA 2011).

Several diagonal-stay kits are available. A single operator can install them quickly, without using a tractor-mounted post driver. Box ends, on the other hand, take longer to install and, to ensure the posts are properly anchored, need a tractor-mounted post driver (Pelletier 2012).

In most cases, diagonal stays are adequate.

Materials

You can construct strainer assemblies from concrete, steel or timber. When deciding on the most suitable material for your strainer assemblies, you should consider construction issues, durability and resistance to natural disasters. Table 6.1 examines these considerations.

Table 6.1 – Assessment of strainer assembly materials

Assessment factors		Strainer assembly material		
Criteria	Item	Concrete	Steel	Timber
Construction	Cost	✓ Relatively inexpensive	✗ More expensive	✓ Relatively inexpensive
	Handling	✗ Heavy to handle	✓ Relatively light to handle	✓ Relatively light to handle
	Installation		✓ Can be installed quickly (e.g. drivable by hand or machine, with no boring required)	
Durability	Rot and termite attack	✓ Termite-proof	✓ Termite-proof	✗ Can rot and/or be eaten by termites if not treated ✓ Can be treated to make it last longer
	Rust	✗ Reinforcement can corrode in wet, acidic or salty areas	✗ Can rust and/or corrode (the risk is higher in coastal, wet, acidic or salty areas) ✓ Can be galvanised to prevent rusting (but this is more expensive)	
Resistance to natural disasters	Fire	✓ Can be affected by fire (e.g. it can lose structural integrity in a hotter fire)	✓ Good in high-fire-risk areas as it provides some resilience to fire, although a hotter fire will damage the galvanised coating	✗ Easily burnt by a bushfire
	Flood	✗ Can be brittle and prone to damage if struck by large logs during a flood		✗ Can warp, crack or split over time ✗ Very buoyant and has been known to float out of the ground in deep floodwaters

Sources: http://www.agric.wa.gov.au/objtwr/imported_assets/content/fm/small/fn_fencing08.pdf;
<http://www.quikfence.com.au/1279/benefits-of-using-galvanised-strainer-posts-for-rural-fencing/>.

Cost

A strainer assembly can range in cost from less than \$200 (using treated pine) to greater than \$300 (using steel). Tables 6.2, 6.3 and 6.4 show cost estimates for typical steel, concrete and treated pine strainer assemblies.

Table 6.2 – Cost estimates for a steel strainer assembly

Item	Units required	Unit cost	Cost
Pipe (150 mm dia. x 3 m long, driven in)	1	\$80	\$80
Stay (40 nominal bore galvanised pipe x 3.25 m long)	1	\$23	\$23
Stay block (concrete)	1	\$13	\$13
Conmix (to concrete in)	1	\$50	\$50
		Subtotal (ex GST)	\$166
Labour	1	\$150	\$150
		Total (ex GST)	\$316

Note: cost estimates are based on 2013–14 dollars.

Table 6.3 – Cost estimates for a concrete strainer assembly

Item	Units required	Unit cost	Cost
Post (150–170 mm x 2.13 m long)	1	\$55	\$55
Stay (galvanised pipe 3.25 m long)	1	\$23	\$23
Stay block (concrete)	1	\$13	\$13
Conmix (to concrete in)	1	\$50	\$50
Subtotal (ex GST)			\$141
Labour	1		\$140
Total (ex GST)			\$281

Note: cost estimates are based on 2013–14 dollars.

Table 6.4 – Cost estimates for a treated pine strainer assembly

Item	Units required	Unit cost	Cost
Treated pine post (150–200 mm dia. x 2.4 m long)	1	\$24	\$24
Treated pine post (150–200 mm dia. x 2.1 m long)	1	\$21.50	\$21.50
Treated pine rail (75–100 mm dia. x 3 m long)	1	\$16.50	\$16.50
Pins (12 mm rod x 350 mm long)	1	\$8	\$8
Bracing wire	1	\$10	\$10
Subtotal (ex GST)			\$80
Labour	1		\$90
Total (ex GST)			\$170

Note: cost estimates are based on 2013–14 dollars.

6.2.2 Construction considerations

The key things you should consider when constructing a strainer assembly in a flood-prone area are the depth of the strainer post and the method of setting it.

Strainer post depth

Depending on the type of soil⁷, strainer posts are typically set 75–90 cm into the ground. While this is adequate for most fences, a fence exposed to additional loads (such as during a flood) should have its strainer posts set deeper so they can carry a heavier load, and to reduce their horizontal and vertical movement. Table 6.5 shows how a deeper post can carry a heavier load.

Therefore, in flood-prone areas, you should use longer strainer posts (for example, 2.7 m), with about half set into the ground.

Table 6.5 – Effect of setting strainer posts deeper in the ground

	Depth of post	
	75 cm deep	90 cm deep
Total load carried	20 kN	50 kN
Horizontal movement at 13 kN	40 mm	25 mm
Vertical movement at 13 kN	15 mm	10 mm

Source: <http://www.acga.org.au/goatnotes/B005.php>

⁷ Posts in sandy soils should be dug deeper into the soil than posts in clay soils (Staton and O’Sullivan 2006).

Setting the strainer post

Staton and O’Sullivan (2006) state that a driven post will be 1.5 times more secure than a post placed in an oversized hole with the earth rammed back around it. Table 6.6 compares the two techniques.

Table 6.6 – Effect of driving a strainer post versus placement and backfilling/ramming

	Depth of post	
	Driven	Backfilled / rammed
Total load carried	26 kN	18 kN
Horizontal movement at 13 kN	40 mm	100 mm
Vertical movement at 13 kN	10 mm	50 mm

Source: <http://www.acga.org.au/goatnotes/B005.php>

Therefore, wherever possible in flood-prone areas, you should drive strainer posts into undisturbed soil rather than put them in an oversized hole, backfill with earth and ram.

Where driving is not an option, the next best approach is to drill post holes, ensuring the strainer post diameter is only slightly less than the auger.

6.3 Strengthening in-line posts

As well as strengthening the strainer assemblies, you can also strengthen in-line posts to resist overturning during flood events. This involves considering the type of post, their depth and the spacing between them.

6.3.1 Post types

DELWP’s *Vegetation Works Standards* (DSE 2011) identified types of in-line post—such as treated pine, concrete, recycled plastic and heavy-duty galvanised pipe—suitable for livestock fencing. Other options are large red gum posts, railway line and star pickets.

As with strainer assemblies, when deciding on the most suitable type of in-line post, you should consider construction issues, durability and resistance to natural disasters. Table 6.7 examines these considerations.

For floodplain fencing, the stronger types of post (such as concrete and steel, including steel pipe and strong star pickets) are generally better.

Table 6.7 – Assessment of in-line post materials

Assessment factors		In-line post material					
Criteria	Item	Concrete	Treated pine	Recycled plastic	Steel pipe	Red gum	Star pickets
Construction	Cost	<ul style="list-style-type: none"> ✓ Relatively inexpensive 	<ul style="list-style-type: none"> ✓ Relatively inexpensive 	<ul style="list-style-type: none"> ✗ More expensive 	<ul style="list-style-type: none"> ✗ More expensive 	<ul style="list-style-type: none"> ✗ More expensive and more difficult to source 	<ul style="list-style-type: none"> ✓ Relatively inexpensive ✗ More expensive for longer/stronger pickets (can be twice the cost)
	Handling	<ul style="list-style-type: none"> ✗ Heavy to handle 	<ul style="list-style-type: none"> ✓ Relatively light to handle 	<ul style="list-style-type: none"> ✓ Light to handle 	<ul style="list-style-type: none"> ✓ Relatively light to handle 	<ul style="list-style-type: none"> ✗ Heavy to handle 	<ul style="list-style-type: none"> ✓ Less bulky than timber, concrete and pipe
	Installation			<ul style="list-style-type: none"> ✓ Can be installed quickly (e.g. driven by hand or machine) 	<ul style="list-style-type: none"> ✓ Can be installed quickly (e.g. driven by hand or machine) 		<ul style="list-style-type: none"> ✓ Requires no machinery to install
Durability	Rot and termite attack	<ul style="list-style-type: none"> ✓ Termite-proof 	<ul style="list-style-type: none"> ✗ Can rot and/or be eaten by termites if not treated ✓ Can be treated to make it last longer 	<ul style="list-style-type: none"> ✓ Rot- and termite-proof 	<ul style="list-style-type: none"> ✓ Termite-proof 	<ul style="list-style-type: none"> ✓ Relatively rot- and termite-proof 	<ul style="list-style-type: none"> ✓ Termite-proof
	Rust	<ul style="list-style-type: none"> ✗ Reinforcement can corrode in wet, acidic or salty areas 		<ul style="list-style-type: none"> ✓ Rustproof 	<ul style="list-style-type: none"> ✗ Can rust and/or corrode (the risk is higher in coastal, wet, acidic or salty areas) ✓ Can be galvanised to prevent rusting (but that is more expensive) 		<ul style="list-style-type: none"> ✗ Can corrode (although a hot-dipped galvanised coating makes posts suitable for use in medium to highly corrosive environments)
Resistance to natural disasters	Fire	<ul style="list-style-type: none"> ✓ Can be affected by fire (e.g. they can lose structural integrity in a hotter fire) 	<ul style="list-style-type: none"> ✗ Easily burnt by bushfire 		<ul style="list-style-type: none"> ✓ Good in high-fire-risk areas as they provide some resilience against fire, although a hotter fire will damage the galvanised coating 	<ul style="list-style-type: none"> ✗ Easily burnt by bushfire 	
	Flood	<ul style="list-style-type: none"> ✗ Can be brittle and prone to damage if struck by large logs during floods 	<ul style="list-style-type: none"> ✗ Can warp, crack or split over time ✗ Very buoyant and have been known to float out of the ground in deep floodwaters 				<ul style="list-style-type: none"> ✗ Can bend over during floods ✓ Some longer and stronger pickets are available that can resist higher pressures

6.3.2 Post depth

As with strainer posts, in-line posts exposed to floods should be longer and set deeper into the ground than standard fence posts. This will reduce the risk of overturning.

6.3.3 Post spacings

In-line posts:

- provide extra support to the wires, by absorbing some of their weight
- maintain proper wire spacing
- prevent overturning
- keep wires at the required height.

In-line posts are not designed to add appreciable strength or rigidity to the fence (Quinton 1990).

During floods, debris loads can increase the risk of posts overturning. Therefore, you should preferably reduce post spacings⁸ in sections of a fence that are more likely to encounter flood debris.

Also, when locating a fence across a flood breakout in a floodplain, you will need more posts and/or tie downs to keep the fence down. To reduce the chance of debris catching on the fence, have as few pickets in the low-flow channel as possible. Preferably, place a picket either side of the low-flow channel. You can achieve this with star pickets located in flood breakouts, braced with short tie downs (that is, two 60 cm star pickets inserted at 45° angles at the base of the vertical picket). This will help the fence withstand greater force without increasing the number of posts required.

6.4 Other design options

Other design options to increase the strength of a fence include the type, number and placement of fencing wires; the fence height; and the location of gates.

6.4.1 Fencing wire

Type

The most common types of livestock exclusion fencing are:

- conventional fencing (standard post-and-wire fencing, typical on many rural properties)
- mesh fencing (prefabricated wire fencing—for example, ring-lock or hinge joint—often used for sheep)
- electric fencing (often added to conventional fencing to increase livestock control).

Table 6.8 compares these types of fencing. Tables 6.9, 6.10 and 6.11 compare the costs.

⁸ Department of Sustainability and Environment (2011) states that the general in-line post spacing for livestock control should be 8–10 m, with either:

- wooden, steel or plastic droppers at 2.5–3 m spacings, or
- 1.65 m or 1.8 m steel pickets at 4–5 m spacings.

However, site conditions determine the most suitable spacing of posts: for example, wider spacings are possible on flat country. Therefore, the spacings above are provided as a guide only.

Table 6.8 – Assessment of fence types

Assessment factors		Fence type		
Criteria	Item	Conventional	Mesh	Electric
Design	Livestock type	<ul style="list-style-type: none"> ✓ Relatively effective with cattle ✗ Less effective with sheep than mesh fencing <p>Additional wires can improve effectiveness with sheep and lambs</p>	<ul style="list-style-type: none"> ✓ Forms a solid, impenetrable barrier to cattle, sheep and some vermin ✓ Stronger than conventional fences at the same post spacings ✓ Most effective with lambs 	<ul style="list-style-type: none"> ✓ Effective with a range of livestock and feral animals ✗ Not as effective with sheep (but additional wires and closer spacing can improve effectiveness)
	Wildlife movement		<ul style="list-style-type: none"> ✗ Can restrict wildlife movement 	<ul style="list-style-type: none"> ✗ Can electrocute wildlife
Construction	Cost	<ul style="list-style-type: none"> ✓ Relatively inexpensive, compared to mesh fencing <p>Higher cost if droppers (used to spread livestock pressure from a single wire to all wires in a fence) are needed, depending on post spacing</p>	<ul style="list-style-type: none"> ✗ Expensive in relation to other types of fencing 	<ul style="list-style-type: none"> ✓ Comparatively inexpensive
	Installation		<ul style="list-style-type: none"> ✓ Can be installed quickly (e.g. drivable by hand or machine, no boring is required) 	<ul style="list-style-type: none"> ✓ Quick to erect: less wire, and fewer and smaller posts, are required <p>Needs a reliable power source and a strong electric current</p>
Durability	Maintenance			<ul style="list-style-type: none"> ✗ More labour-intensive, fence must be checked regularly for shorts <p>Vegetation and native and feral animals can cause shorting (the risk of vegetation shorting can be reduced by slashing or spraying along fence lines)</p>
	Repair	<ul style="list-style-type: none"> ✓ Simple to repair 	<ul style="list-style-type: none"> ✓ Copes well with minor damage, as snapped wires are supported by surrounding wires ✗ Difficult to repair if many wires are cut 	
Resistance to natural disasters	Flood	<ul style="list-style-type: none"> ✓ Does not collect as much flood debris as mesh ✓ Simple to cut if a flood is imminent, to reduce damage; can be designed to lay down in flood events 	<ul style="list-style-type: none"> ✗ Susceptible to flood damage 	<ul style="list-style-type: none"> ✓ Relatively flood-proof ✓ Can be used easily to fence off livestock crossings and watering points ✓ Easy to move (so good for temporary fencing)

Note: Table adapted from:

- Department of Sustainability and Environment (2006). *Native Vegetation Revegetation Planting Standards - Guidelines for Establishing Native Vegetation for Net Gain Accounting*. Department of Sustainability and Environment, Victorian Government, East Melbourne.
- Staton, J. and O’Sullivan, J. (2006). *Stock and Waterways: A Manager’s Guide*. Land & Water Australia, Canberra.

Table 6.9 – Cost estimates per km for a standard (7-wire) conventional fence

Item	Unit	Units/km	Unit cost	Cost/km
Plain wire (1500 m roll)	roll	5	\$200	\$1000
Treated pine post (100–125 mm x 1.8 m)	each	84	\$9	\$756
Black star post (1.65 m)	each	166	\$7	\$1162
			Subtotal (ex GST)	\$2918
Labour and machinery	metre		\$7	\$7000
			Total (ex GST)	\$9918

Note: cost estimates are based on 2013–14 dollars.

Table 6.10 – Cost estimates per km for a standard (7/90/30) mesh fence

Item	Unit	Units/km	Unit cost	Cost/km
Plain wire (1500 m roll)	roll	4	\$200	\$800
7/90/30 mesh (200 m roll)	roll	5	\$280	\$1400
Treated pine post (100–125 mm x 1.8 m)	each	84	\$9	\$756
Black star post (1.65 m)	each	166	\$7	\$1162
			Subtotal (ex GST)	\$4118
Labour and machinery	metre		\$8	\$8000
			Total (ex GST)	\$12,118

Note: cost estimates are based on 2013–14 dollars.

Table 6.11 – Cost estimates per km for a standard (4-wire) electric fence

Item	Unit	Units/km	Unit cost	Cost/km
Plain wire (1500 m roll)	roll	3	\$200	\$600
Treated pine post (100–125 mm x 1.8 m)	each	63	\$9	\$567
Black star post (1.65 m)	each	187	\$7	\$1309
Post insulator	each	500	\$0.50	\$250
			Subtotal (ex GST)	\$2726
Labour and machinery	metre	1000	\$6	\$6000
			Total (ex GST)	\$8726

Note: cost estimates are based on 2013–14 dollars.

In relation to fencing in flood-prone areas, DELWP's *Vegetation Works Standards* (DSE 2011) noted:

- conventional fencing does not collect as much flood debris as mesh fencing or barbed wire
- mesh fencing is susceptible to flood damage
- electric fencing is relatively flood-proof.

Also, a plain wire fence is generally easier to clean-up after a flood event and easier to re-strain, although this often depends on the number of wires in the fence.

As such, you should avoid installing mesh fencing and barbed wire in flood-prone areas.

Number of wires

Fence damage from floodwaters is usually caused by the build-up of flood debris against the fence. The accumulated debris provides a wide surface area for the flowing water to push against, leading to the fence failing (NECMA 2009).

Therefore, keeping the number of wires to a minimum helps to limit the load a fence carries during a flood, by reducing the ability of the fence to catch debris. For example, a 4-wire fence will collect less debris than a 7-wire fence.

For this reason, electric fences (which use fewer wires than other conventional fences) are often the best choice in flood-prone areas.

Placement

You should place fencing wires on the paddock or downstream sides of posts so the wires pop their staples and drop, rather than break. Figure 6.3 illustrates this.

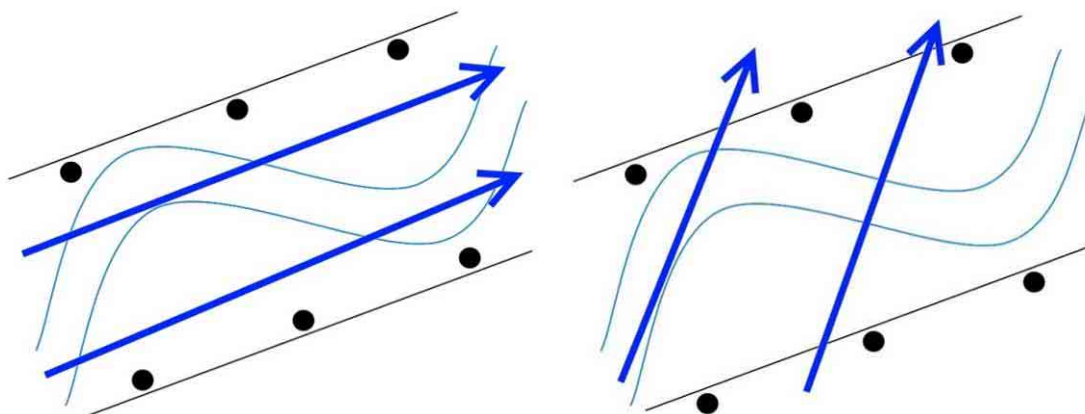

Figure 6.3 – Placement of wire on fence posts where the flood flow follows the stream course

To make fencing wire pop more easily, you should use unbarbed staples. An alternative is to use a combination of barbed and unbarbed staples. For example, for a 5-wire fence, you could use barbed staples for wires one, three and five, and unbarbed for wires two and four. This would make the fence partially sacrificial during a flood—wires two and four could break away, increasing the spacing between wires one, three and five to limit debris collection) while maintaining its immediate post-flood livestock control function.

6.4.2 Fence height

Agriculture WA 1993 (as cited in Water and Rivers Commission 2000) notes that the height of a fence is a critical factor in determining its stability during flood events. The taller the fence, the less stable it becomes during a flood.

As such, you should construct a fence with the least vertical height possible, to provide adequate livestock control. This is generally between 1.2 m and 1.4 m.

6.4.3 Location of gates

Prefabricated gates are generally constructed with welded mesh. As such, they can be susceptible to flood damage, particularly from flood debris.

Wherever possible, install gates:

- as far from the waterway as possible
- on high ground
- running parallel with the floodwater flow path.

If you cannot do this, consider alternatives such as drop-down or lay-down fencing (for example, a cocky's gate⁹) or a lift-up gate. These alternatives are explained in the next section.

⁹ A cocky's gate is a section of fence hung between two poles and hinged on one side to a gatepost. The other side can be opened and closed by any number of mechanisms. On the opening side, the bottom and top of the pole fit into loops of wire at the base and top of the gatepost, respectively. The gate is opened by being unhooked and dragged out of the way. To stretch the gate tight, the bottom of the gate post is levered into the bottom loop attached to the fence stay and the top of the post is forced towards the stay until the top wire loop can be dropped over it. Alternatively, instead of a top loop, a timber or star-picket handle about a metre long is secured to the gatepost by a length of wire or chain, and used as a lever to pull the top of the gate closed. The handle is then pulled into line with the gate and a free-running loop of wire attached to the gate is slid over the end of the handle to hold it tight (Bush Heritage Australia 2007; http://www.bushheritage.org.au/cdr_history/tracksandroads/gates.html).

7 Making fences more resilient to flood damage

When you cannot align a fence to the floodwater flow path, your next step is to determine if you can design your fence to:

- absorb the impact of a flood
- restore its function post-flood, with limited repairs.

This type of fencing design is known as flood-resilient fencing.

Design options to enable a fence to be re-established and repaired if necessary post-flood include:

- installing collapsible fences
- installing sacrificial fences
- minimising the number of fences crossing a waterway.

7.1 Installing a collapsible fence

During a flood, the floodwater and accumulated debris can damage or destroy a fence, especially if it is not parallel to the floodwater flow path. The most successful designs for a fence facing this risk are:

- a drop-down fence (which gives way under the pressure of floodwater and debris, to lay flat on the ground)
- a lay-down fence (which is folded down manually, so it can't accumulate debris and be damaged during a flood).

Your choice will depend on:

- location: if the project site is prone to sudden flooding, or access to the fence is poor, choose a drop-down fence over a lay-down fence (Staton and O'Sullivan 2006)
- repair costs: during a flood, a drop-down fence may function unpredictably: for example, the wires may hold for longer than planned. A lay-down fence may be preferable because the landholder has greater control over pre-flood placement, which will minimise repair and re-establishment costs post-flood.

7.1.1 Drop-down fence

A drop-down fence is designed to drop automatically from its anchor points under the pressure of floodwater and debris (Lovett et al. 2003).

There are several types of drop-down fence (Staton and O'Sullivan 2006). The two most common types are wire-hinge and bolt-hinge.

There is a case study about a drop-down fence at Tullaroop Creek, north-central Victoria, on page 40.

Wire-hinge drop-down fence

For this type of drop-down fence, you attach wooden droppers to the posts (which are usually steel pickets), using loops of low-tensile wire at the top and high-tensile wire at the bottom. Figure 7.1 shows this.



Figure 7.1 – A wooden dropper attached to a star picket

The softer, low-tensile wire at the top is intended to break under high pressure, while the high-tensile wire remains intact and acts as a hinge. When the top loop breaks, the fence lies flat, releasing any debris (Staton and O'Sullivan 2006). Figure 7.2 shows a typical design.

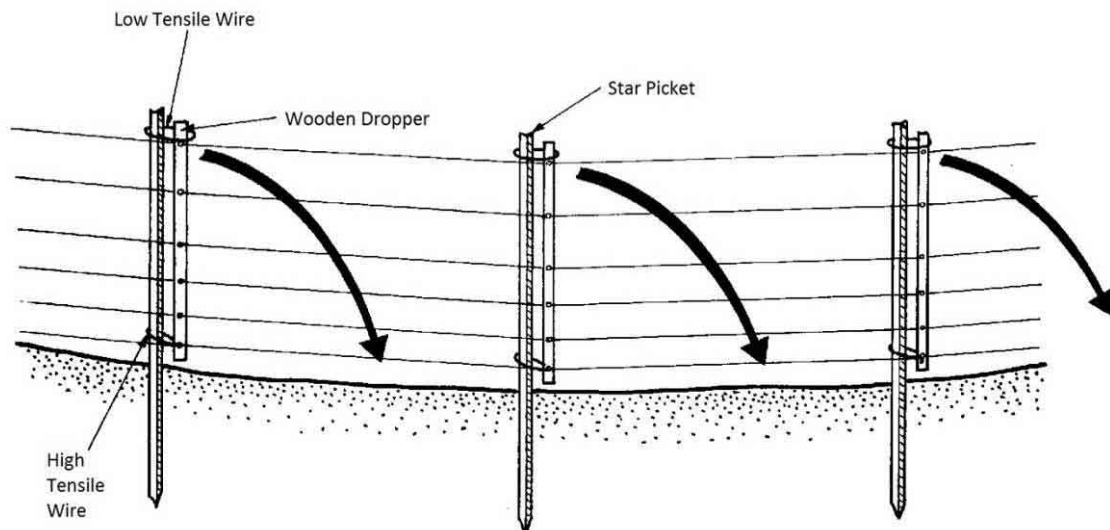

Figure 7.2 – Drop-down fence using high-tensile wire as the bottom hinge
(source: Water and Rivers Commission 2000)

Similarly, it is possible to have a drop-down strainer post which will also allow the fence to lay flat on the ground in a flood (Water and Rivers Commission 2000). Figures 7.3 and 7.4 show this. Figure 7.4 also shows that you can use chain in a figure-eight configuration as the bottom hinge.

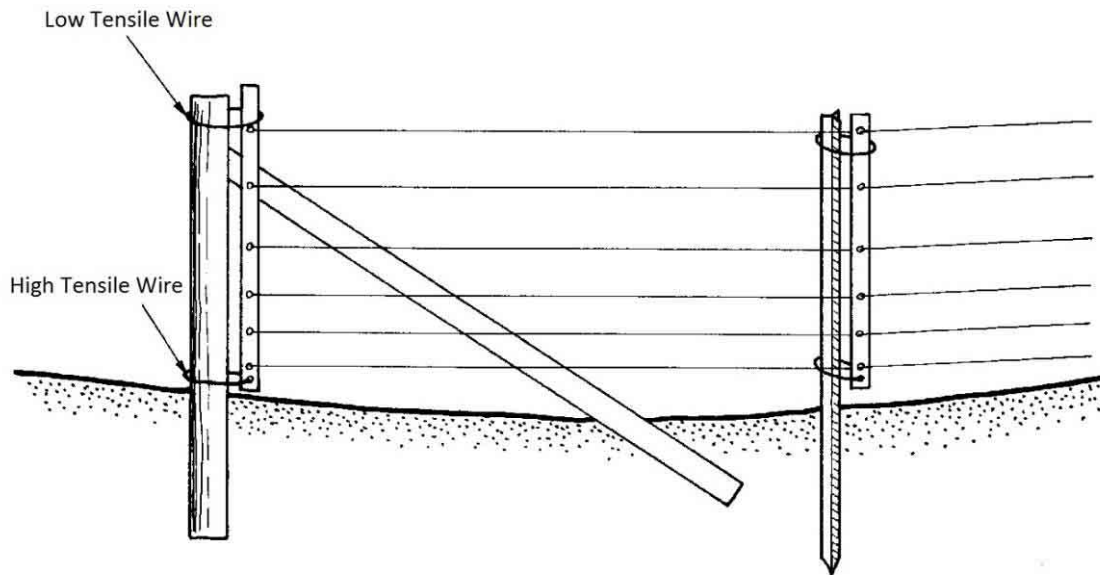

Figure 7.3 – Drop-down strainer posts using high-tensile wire as the bottom hinge
 (source: Water and Rivers Commission 2000)



Figure 7.4 – Drop-down end assembly using chain in a figure-eight configuration as the bottom hinge

Bolt-hinge drop-down fence

This type of drop-down fence uses bolts as the bottom hinge. Figures 7.5 and 7.6 show how this works for the fence and strainer post.

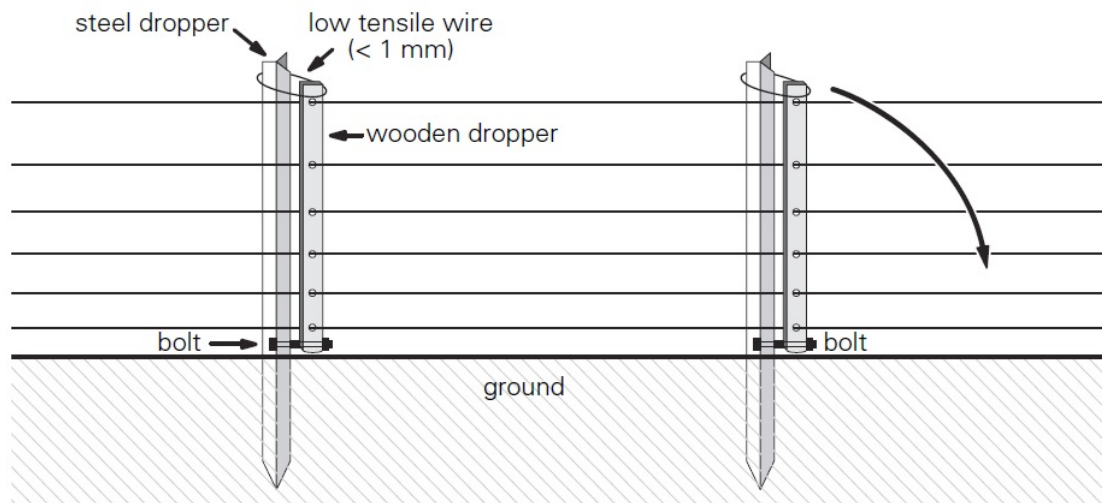

Figure 7.5 – Drop-down fence using bolts as the bottom hinge (source: Staton and O'Sullivan 2006)

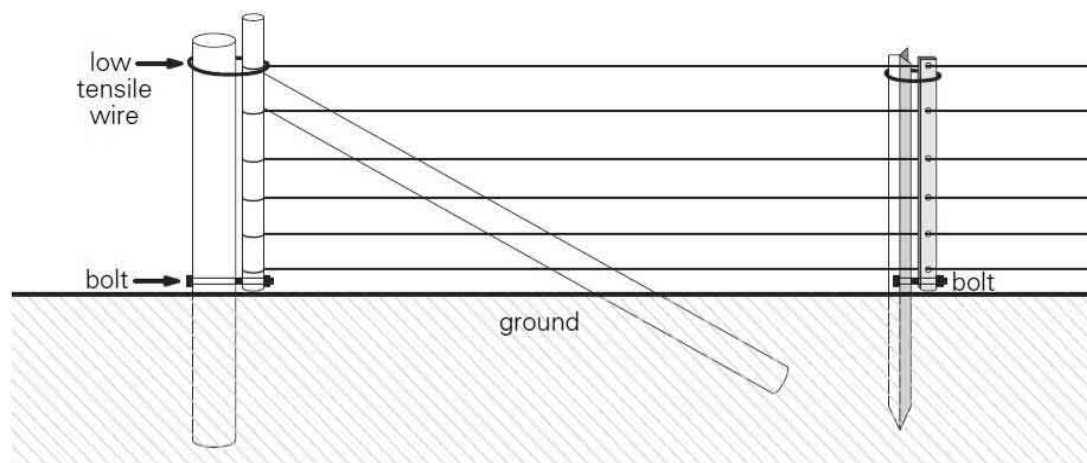

Figure 7.6 – Drop-down strainer post using bolts as the bottom hinge (source: Staton and O'Sullivan 2006)

Construction considerations

Drop-down fences can be simple to construct (Water and Rivers Commission 2000):

- set star pickets deep in the ground so that they will hold during most floods: to do this, use longer star pickets than normal
- attach droppers to the wires so the droppers don't touch the ground when they are upright.

Maintenance and flood recovery

Properly designed and constructed drop-down fences are strong enough to withstand usual livestock pressures and need little maintenance (Water and Rivers Commission 2000, NCCMA, no date).

Following a flood, drop-down fences are quick and simple to pull back up, reattach to their anchor points and retie to the posts (Lovett et al. 2003, Staton and O'Sullivan 2006).

Case study: Drop-down fence at Tullaroop Creek, north-central Victoria

Lochinver Farm is a cropping and sheep-grazing property north of the township of Carisbrook in north-central Victoria. The main waterway running through the property is Tullaroop Creek, which receives flows from an upstream catchment area of 1240 km².

Riparian rehabilitation works on the property have been ongoing since the late 1990s, and additional riparian fencing was planned for 2011–12.

However, after seeing the impact of the January 2011 flood—an extreme flood event estimated to be a 1:135 year event—the landholder decided to modify the fence design to a drop-down fence.

As most of the property is inaccessible during a flood, and there can be little warning that a flood is coming, the fence was designed to drop down under the force of a flood.



Figure 7.7 – The wire holding the top of the drop-down stay is designed to let go under flood force

This reduces the risk to the landholder and frees up necessary time for the landholder for essential pre-flood tasks (such as shift livestock and safeguard infrastructure).

The fence has a drop-down stay at one end of each fence strain, and a solid stay at the other end (which is usually upstream). This design was adopted partly because the landholder had already purchased the fencing materials before the 2011 flood, and also because they, and the North Central

CMA, considered the upstream stay would be more resilient to the force of the floodwater.

Key aspects of the fence design are:

- the tops of the drop-down stays aren't tied off strongly to the posts; they are just tied with one or two twists, so they let go under flood force
- the bottoms of the drop-down stays are attached to the posts with chain in a figure-eight configuration, so they can be strained when being reset after a flood
- the wooden droppers are attached to the star pickets with low-tensile wire at the top and high-tensile wire at the bottom
- it uses seven-strand plain wire with three electrified strands
- the wire spacings are closer towards the ground (for sheep control)
- posts are spaced 6 m apart
- the fence is 1.2 m high
- sacrificial fencing, which is not connected to the main fence, is used at the creek crossing.

At the time of publication of the guidelines, the fence had not yet been tested under flood conditions.



Figure 7.8 – A wooden dropper attached to a star picket

7.1.2 Lay-down fence

A lay-down fence is designed to be folded down manually before a flood, so it can't accumulate debris and be damaged during a flood (Staton and O'Sullivan 2006, Lovett et al. 2003). This type of fence is only suitable if there is good flood forecasting for the project site.

There are several types of lay-down fences, ranging from the simple cocky's gate to more sophisticated systems (Staton and O'Sullivan 2006).

Generally, you construct a lay-down fence in the same way as a drop-down fence (NCCMA undated). The fence is dropped by flipping up the top loop and lifting the stays out of the bottom loop.

There is a case study about a lay-down fence at Glenelg River, Warrock, south-west Victoria, on page 42.

7.2 Installing a sacrificial fence

Studies in the eastern states of Australia by Bell and Priestley (as cited in Water and Rivers Commission 2000) show that conventional fences, even with heavily engineered designs, fail when installed across the path of a significant flood. This is due to the immense forces imposed by deep, fast-flowing, debris-laden floodwaters and the build-up of debris on the fence, forming a dam which eventually fails.

As such, in areas susceptible to regular floods, it can be more cost-effective to install a fence that is cheaper and simpler to replace than conventional fencing. This type of fence is commonly referred to as a sacrificial fence. The two main types of sacrificial fence are:

- a full-length sacrificial fence: with strong end assemblies and with the wire and inline posts designed to be sacrificed
- a high-risk sacrificial fence: with isolated, high-risk sections designed to be sacrificed.

There is a case study about a sacrificial fence at Black Range Creek, north-east Victoria, on page 46.

7.2.1 Full-length sacrificial fence

The simplest and cheapest sacrificial fence design is the type using star picket posts and wires shown in Figure 7.11. Compared to a conventional fence, this type:

- replaces in-line posts with star pickets (as detailed in Table 7.1)
- has fewer wires (typically by changing from conventional to electric fencing).

With this type of fence, the star pickets and wire are designed to be sacrificed, while the strainer (end) assemblies are permanent.



Figure 7.11 – Full-length sacrificial fence

Case study: Lay-down fence at Glenelg River, Warrock, south-west Victoria

During dry conditions, unfenced reaches of the Glenelg River at Warrock allow livestock to enter the river channel and, at times, cross to and from neighbouring properties. During floods, livestock are at risk from the floodwaters.

The Glenelg Hopkins CMA offered the Currie family incentives to fence off the river frontage and establish riparian plantings as part of the CMA's Glenelg River Restoration Project.

Between 2007–09, the Currie family constructed over 6 km of fencing along the Glenelg River at Warrock. Due to the size of the project and the length of the waterway on the floodplain, the family opted for lay-down fencing to ensure it would be resilient to the regular floods on the property.

The lay-down fence was designed to withstand significant floods by allowing floodwater to flow over the fence, which is dropped and then held on the ground along its length.



Figure 7.9 – Strained fence length in drop-down position (photo: Glenelg Hopkins CMA)

Key aspects of the fence design are:

- the hinged steel end assemblies (for which a patent is pending), designed by the family
- end assemblies fabricated to ensure that the fence drops in the direction suited to the flow at that section of the river and floodplain
- end assemblies concreted into the ground
- 750 m independent lengths of fence that remain strained, even when in the drop-down position

- plastic droppers (with steel rods inside, for strength) attached to steel posts with bailing twine (or similar low-tensile material) which would break away in the event of an unexpected flood
- seven plain wires
- an easy drop-down mechanism, allowing fast reinstatement of the fence after a flood
- the fence being aligned to the flood path, where possible.



Figure 7.10 – Plastic droppers with metal insert for strength, connected to pine post by bale twine

As the fence project had an extensive design and testing stage, it cost at least double that of a usual fence. However, the family believes that savings could be made by reducing the number of pine posts between the end assemblies—every third post could go—and premanufacturing the end assemblies.

An essential aspect of the project was the family's knowledge of flood behaviour on the property, including of floodwater flow paths during different flood events. The use of LiDAR or similar tools could help with planning projects like this.

Since it was built, the fence has survived large floods in September 2010 and February 2011. The February 2011 flood was estimated to be a greater-than-1:50-year event.

The fence was designed to allow easy drop down pre-flood and to require minimal maintenance post-flood. It takes about 1.5 hours to drop down the 6 km fence. Importantly, it only took about four hours to stand it back up, and remove the debris, after the February 2011 flood.

Table 7.1 – In-line posts for conventional and sacrificial fencing

		Conventional post and wire fence	Sacrificial star picket post and wire fence
In-line posts	Spacing (m)	10	50
	Number per km	100	20
Star pickets	Spacing (m)	5	3
	Number per km	100	313

Note: cost estimates based on 2013–14 dollars.

Excluding end assemblies, modifying a conventional fence to be a sacrificial fence only slightly reduces its cost. Tables 7.2 and 7.3 show the cost reduction to be about \$600 per km. Table 7.4 shows the cost reduction increases to about \$1600 per km if compared to the cost of installing a typical drop-down fence. However, repair and replacement costs for the sacrificial fence after a flood could easily amount to this difference, if not more.

As such, it is arguable whether full-length sacrificial fences are cost-effective in the long term.

Table 7.2 – Cost estimates per km for a conventional post and 7-wire fence

Item	Unit	Units/km	Unit cost	Cost/km
Plain wire (1500 m roll)	roll	5	\$200	\$1000
Treated pine post (100–125 mm x 1.8 m)	each	84	\$9	\$756
Black star post (1.65 m)	each	166	\$7	\$1162
			Subtotal (ex GST)	\$2918
Labour and machinery	metre		\$7	\$7000
			Total (ex GST)	\$9918

Note: cost estimates are based on 2013–14 dollars.

Table 7.3 – Cost estimates per km for a sacrificial star picket post and 4-wire electric fence

Item	Unit	Units/km	Unit cost	Cost/km
Plain wire (1500 m roll)	roll	3	\$200	\$600
Treated pine post (100–125 mm x 1.8 m)	each	20	\$9	\$180
Black star post (1.65 m)	each	313	\$7	\$2191
Post insulator	each	666	\$0.50	\$333
			Subtotal (ex GST)	\$3304
Labour and machinery	metre	1000	\$6	\$6000
			Total (ex GST)	\$9304

Note: cost estimates are based on 2013–14 dollars.

Table 7.4 – Cost estimates per km for a drop-down 7-wire fence with 3 hot wires

Item	Unit	Units/km	Unit cost	Cost/km
Plain wire (1500 m roll)	roll	5	\$200	\$1000
Black star post (1.65 m)	each	166	\$7	\$1162
Wooden dropper	each	166	\$3	\$498
Post insulator	each	498	\$0.50	\$249
			Subtotal (ex GST)	\$2909
Labour and machinery	metre		\$8	\$8000
			Total (ex GST)	\$10,909

Note: cost estimates are based on 2013–14 dollars.

7.2.2 High-risk sacrificial fence

In many cases, a project site may not require a full-length sacrificial fence, if high-risk sections can be isolated. Typically, high-risk sections are those where a fence must:

- cross a waterway
- run perpendicular to the stream flow (such as with a boundary fence)
- cross a flood break-out.

In these cases, a sacrificial fence should be isolated from other fences and use separate strainer assemblies. This way, should the fence be demolished in a flood, it will not take other fencing with it.

Another option is to install floodgates, as explained in section 7.3.

7.3 Minimising fences crossing waterways

Wherever possible, build as few fences as possible across a waterway, particularly in flood-prone areas. However, where you cannot avoid building a fence across a waterway, it should:

- be built independently of other fences, to avoid damage to large lengths of fencing
- be in a straight section of the waterway or at the crossover point in the middle of a meander, where the main flow is naturally directed to the centre of the channel
- consider natural high points on the longitudinal profile, thus reducing the fence height.

Before building a fence across a waterway, you should consider recreational use of the waterway, and whether the fence will be a threat to people canoeing, boating or doing other recreational activities on the waterway.

7.3.1 Alternatives to fences

Floodgates are often used as an alternative to standard fences when crossing waterways. The main types of flood gate are electrified floodgates, suspended hanging floodgates and hinged floodgates.

Electrified floodgates

For an electrified floodgate, lengths of galvanised chain are hung from a chain line wire strung between posts, one on either side of the waterway. The lengths of chain should be no more than 30 cm above the lowest average water level in the stream.

There should be a cut-out switch between the fence and the floodgate, to cut the power to the floodgate during a flood while maintaining power to the rest of the fence.

Suspended hanging floodgates

For a suspended hanging floodgate, galvanised chain, chain mesh, galvanised iron, prefabricated fencing or netting is attached to a steel cable or chain that is suspended across the waterway between two secured posts.

During a flood, the cable remains taut while the floodgate fence remains flexible and rises with the floodwater. You can use foam or plastic floats to float the floodgate on the floodwater surface.

Hinged floodgates

For hinged floodgates, a conventional wire fence is suspended across the waterway with a wooden or welded steel frame gate hung from the lower cable that will move up in the flow.

These floodgates have limited application because the conventional fence component will collect debris if the flood goes overbank.

Case study: Sacrificial fence, Black Range Creek, north-east Victoria

Black Range Creek near Milawa in north-east Victoria is subject to severe bed and bank erosion during flood events. In the February 2011 flood, the stream deepened by at least 1 m at some points, and had some small course changes.

Undertaking stream rehabilitation works (such as riparian fencing) is difficult on such an actively eroding stream. Careful planning and knowledge of the likely future erosion processes are needed to protect the fence and any vegetation that is to be planted.

Also, floods in the catchment occur very quickly and with little warning. This means drop-down or other manually manipulated fences are not options.



Figure 7.12 – Pine posts at 50 m spacings with steel pickets every 3 m, four plain wires including two electric

The North East CMA flood recovery team worked with landholders in the Black Range Creek valley to fence and revegetate the stream frontage. By removing cattle from the stream frontage, providing rock armouring at potential avulsion points and allowing a wide buffer, they aim to minimise erosion in future.

On the project site, the Black Range Creek and King River flow parallel before they join further downstream, with the potential for an avulsion to bring the two rivers together further upstream.

The North East CMA and landholders decided to construct a fence that was largely sacrificial, acknowledging the high stream power and potential for course changes.

Key features of the fence are:

- it uses pine posts about 50 m apart, with (sacrificial) star pickets every 3 m
- it has four plain wires, two of which are electric



Figure 7.13 – Independent, short sections of fence where flows are expected to be particularly fast, and a point of potential avulsion

- the end assemblies are concreted into the ground
- it has independent sections of fence where flows are expected to be particularly fast
- it has a stream crossing constructed with electrified suspended chain, which is very effective in controlling cattle (including young livestock) during times of low flow; the chain is lightweight and cheap to replace if damaged in a flood
- it is aligned to the floodwater flow path, where possible.



Figure 7.14 – Suspended chain on electrified wire

During a flood, it is likely that the wires and star pickets would be damaged, but that the end assemblies and pine posts would remain in place.

This is a relatively cheap fence to construct. Landholders expect to manage maintenance of the fence after future floods.

8 References

- Brierley, G., Fryirs, K., Outhet, D. and Massey, C. (2002). *Application of the River Styles framework as a basis for river management in New South Wales, Australia*. *Applied Geography*, 22, 91-122.
- Bush Heritage Australia (2007). *Run throughs, gates and grids*. At http://www.bushheritage.org.au/cdr_history/tracksandroads/gates.html
- California Department of Water Resources (2005). *Natural Floodplain Functions and Societal Values. Revised Draft*.
- Charlton, R. (2007). *Fundamentals of Fluvial Geomorphology*. Routledge.
- Commonwealth Scientific and Industrial Research Organisation (2011). *Fencing Livestock In - Virtually*. Retrieved 27 November 2013 from <http://www.csiro.au/Organisation-Structure/Flagships/Sustainable-Agriculture-Flagship/Virtual-Fencing-Project.aspx> (web page no longer available).
- Costermans, L. (1989). *Native Trees and Shrubs of South-Eastern Australia*. New Holland.
- Department of Agriculture and Food Western Australia (2011). *First Time Fencing Unravalled*. Small Landholder Series. Note 310. Western Australian Agriculture Authority.
- Department of Primary Industries New South Wales (2012). *Fencing Riparian Zones*. <http://www.dpi.nsw.gov.au/fisheries/habitat/rehabilitating/habitats/fencing-riparian-zones>.
- Department of Sustainability and Environment (2011). *Vegetation Works Standards. Victorian Investment Framework*. Department of Sustainability and Environment.
- Department of Sustainability and Environment (2009). *Floodplain Management*. Retrieved from Our Water Our Future: <http://www.ourwater.vic.gov.au/environment/floodplains/floodplain-management> (web page no longer available).
- Emergency Management Australia (1999). *Managing the Floodplain. Manual 19*. Australian Government.
- Filmer, M. (2011). *Virtual fences Set to Transform Farming*. In *Farming Ahead* February 2007 No. 190.
- Gippel, C., Abernethy, B. and Rutherford, I. (1999). *The Riparian Zone and Stream Stability*. The Basics of Riparian Management. River Basin Management Society Inc.
- Gould, L. and Morris, J. (2005). *Riverways: Shortcuts to River Management Information in Australia*. Greening Australia.
- Hickin, E. J. (1974). *The Development of Meanders in Natural River-Channels*. *American Journal of Science*, 274, 414-442.
- Lovett, S., Price, P. and Lovett, J. (2003). *Managing Riparian Lands in the Cotton Industry*. Cotton Research and Development Corporation.
- Makaske, B. (2001). *Anastomosing rivers: a review of their classification, origin and sedimentary products*. *Earth-Science Reviews*, 53, 149-196.
- Melbourne Water (2007). *Flood Management and Drainage Strategy*. Port Phillip and Westernport Region.
- Millar, C.E., Turk, L.M. and Foth, H.D. (1965). *Fundamentals of Soil Science*. John Wiley.
- Ministry of Agriculture, Food and Fisheries, British Columbia (1996). *Fencing factsheet. Gates, cattleguards and passageways*.
- Morisawa, M. (1968). *Streams: their dynamics and morphology*.
- Mussared, D. (1997). *Living on Floodplains*. Cooperative Research Centre for Freshwater Ecology and Murray-Darling Basin Commission: Canberra.
- Nanson, G. C. and Croke, J. C. (1992). *A Genetic Classification of Floodplains*. *Geomorphology*, 4, 459-486.
- North Central Catchment Management Authority (no date). *Riparian fencing & flooding Fact Sheet*.

- North East Catchment Management Authority (2009). *Floodplain Fencing Some Practical Design Concepts for Landholders*.
- Northland Regional Council (2005). *Clean Streams A Guide To Riparian Management in Northland*. Whangarei.
- Northwest Regional Floodplain Management Association (no date). *Floodplain Management Course*. Retrieved from depts.washington.edu/mitigate/norfma.ppt
- OneSteel Wire Pty. Ltd. (2012). *Waratah Fencing Catalogue 2012/13*.
- Parkes, D., Newell, G. and Cheal, D. (2003). *Assessing the quality of native vegetation: The 'habitat hectares' approach*. Ecological Management and Restoration, Vol 4.
- Pelletier, R. (2012). *Fencing Fundamentals*. Weekly Times. At http://www.weeklytimesnow.com.au/article/2012/09/14/537901_farm-news.html (web page no longer available).
- Quinton, D. A. (1990). *Wire fences for livestock management*. Agriculture Canada, Ottawa.
- Riverness Pty Ltd (2013a). *Literature Review and Discussion Paper for Fencing in Flood Prone Areas*. Prepared for the Department of Environment and Primary Industries, Melbourne.
- Riverness Pty Ltd (2013b). *Guidelines for Riparian Fencing in Flood Prone Areas - Post Flood Review Findings and Recommendations*. Prepared for the Department of Environment and Primary Industries, Melbourne.
- Roberts, J., Young, B. and Marston, F. (2000). *Estimating the Water Requirements for Plants of Floodplain Wetlands: a Guide*. Occasional Paper 04/00, Land and Water Resources Research and Development Corporation, Canberra.
- Rust, B. R. (1978). *A Classification of Alluvial Channel Systems*, in Miall, A D (Ed) *Fluvial Sedimentology*, Canadian Society of Petroleum Geologist Memoir, 5, 187-198.
- SCARM (2000). *Floodplain Management in Australia: Best Practice Principles and Guidelines*. CSIRO Publishing, Melbourne.
- Sear, D. A., Newson, M. D. and Thorne, C. R. (2003). *Guidebook of Applied Fluvial Geomorphology*. R&D Technical Report FD1914. DEFRA, London.
- Staton, J. and O'Sullivan, J. (2006). *Stock and waterways: a manager's guide*. Land & Water Australia, Canberra.
- Task Force on the Natural and Beneficial Functions of the Floodplain, Federal Emergency Management Agency (2002). *The natural and beneficial functions of floodplains: reducing flood losses by protecting and restoring the floodplain environment : a report for Congress*. FEMA, Washington D.C.
- Thoms, M., David, N., Rayburg, S. and Southwell, M. (no date). *Busting some myths of Australian floodplain river ecosystems*.
- Wallace, L. (2011). *Finding flood-proof fencing solutions*. In *Farming Ahead*, February 2011, No. 229.
- One Steel Waratah Fencing (2011). *Flood-proof fencing in Cobar - 3rd May 2011*. At <http://www.onesteelwaratah.com.au/About-Waratah/Media-Releases/3rd-May-2011.aspx>
- Water and Rivers Commission (2000). *Water Note WN19 Flood proofing fencing for waterways*. Advisory Notes for Land Managers on River and Wetland Restoration. Government of Western Australia.
- Wright D. and Jacobson T. (2000). *Managing streambanks: Stock control, fencing and watering options*. Department of Primary Industries, Water & Environment, Hobart.

Appendix A: What is a floodplain?

Approaches to defining floodplains (for example, Melbourne Water 2007, SCARM 2000, Roberts et al. 2000 and Task Force on the Natural and Beneficial Functions of the Floodplain 2002) are generally based on flood risk, ecological processes or ecosystem structures. We describe these approaches below.

A1 Flood risk

Floods occur when flows generated by rainfall overtop the banks of a river, creek or constructed channel, or when the amount of runoff exceeds the capacity of underground drainage systems (Melbourne Water 2007). The depth, flow velocity and/or duration of a particular flood can be influenced by:

- rainfall factors (such as magnitude, duration and spatial extent)
- catchment factors (such as catchment area, shape, stream pattern and roughness)
- loss factors (such as infiltration and evaporation)
- storage factors.

Understanding the range of impacts from flooding is essential for effective floodplain management (Melbourne Water 2007).

Floodplain management requires trade-offs between the economic, social and environmental costs and benefits of a broad range of activities on floodplains. It involves applying a range of measures including:

- best-practice guidelines, strategies and processes to manage the flood risk
- studies, flood maps, land-use planning controls, building regulations and research to understand the flood risk, help prevent future flood damage, and minimise threats to life, health and safety
- community awareness, education and training to improve preparedness when a flood occurs
- structural measures to reduce the risk of flooding to existing properties
- flood warning and emergency response measures to manage the flood risk when floods overwhelm existing measures (Department of Sustainability and Environment 2009).

While the measures above address a range of flood events, it is neither economical nor feasible to provide absolute protection against the most extreme floods (that is, against the probable maximum flood ¹⁰).

Planners usually use lesser flood events for planning purposes, compromising between the level of protection communities can afforded and the risk they are prepared to take with the consequences of a larger flood (Emergency Management Australia 1999). Most Australian states and territories have adopted the 1% annual exceedance probability (AEP) flood event for planning and development purposes (SCARM 2000).

¹⁰ The probable maximum flood is the largest flood that could conceivably occur at a particular location. Generally, it is not physically or financially possible to provide protection against such an event.

A2 Ecological processes

Floodplains are fluvial depositional environments formed over long periods from sediments transported by rivers in flood. The rate of floodplain formation depends on the prevailing flow regime in the river and the nature of sediment delivery from the upper catchment (Roberts et al. 2000). Therefore, defining the spatial extent of floodplains from an ecological perspective requires an understanding of both:

- floodplain hydrology (with some typical definitions shown in Box A.1)
- geomorphology (with some typical definitions shown in Box A.2).

Box A.1 – Defining a floodplain from a hydrological perspective

An area of land adjacent to a creek, river, estuary, lake, dam or artificial channel which is subject to inundation by the probable maximum flood (Melbourne Water 2007).

Any area susceptible to inundation by floodwater from any source (California Department of Water Resources 2005).

That area of relatively flat land covered by water during a major flood (Mussared 1997).

Box A.2 – Defining a floodplain from a geomorphological perspective

A temporary alluvial storage area adjacent to the river channel (Thoms et al. no date).

That portion of a drainage basin that is covered by stream-transported sediment that was deposited in or near a stream channel (Northwest Regional Floodplain Management Association no date).

Fluvial depositional environments formed over long periods from sediments transported by rivers in flood (Roberts et al. 2000).

A3 Ecosystem structures

The periodic flooding and related processes of erosion and deposition (as described above) determine, to a considerable extent:

- the shape and features of the floodplain
- the depth and composition of soils
- the type and density of vegetation
- the richness and diversity of wildlife habitats (Task Force on the Natural and Beneficial Functions of the Floodplain 2002).

Identification and mapping of these structural elements is another approach to defining the extent of a floodplain.

A3.1 Floodplain features

The morphology of a floodplain is closely linked with the form and behaviour of the river channel that shapes it (Charlton 2007). Two key processes create floodplain features.

One is lateral accretion from sediment deposition in the channel. This is how floodplains are formed on meandering rivers. The outer bend erodes and sediment is deposited on the inside bend. Through this process of erosion and deposition, the channel gradually moves sideways across the landscape (Gould and Morris 2005).

The other is vertical accretion from floodwater deposition. When a particular flood event exceeds the capacity of a waterway, floodwaters overtop the banks and deposit sediment on the floodplain.

A3.1.1 Lateral accretion

Over long time scales, rivers migrate across valley floors. It is normal for channels to respond to floods and other forces by changing their width, depth and platform. Banks can erode, beds change in depth and channels avulse (Gippel et al. 1999).

Typical floodplain features resulting from lateral accretion include:

- point bars (sediment deposits that develop on the inside of meander bends from material eroded from outside bends)
- billabongs (which occur when meander loops are cut off and abandoned)
- floodplain scour routes (shallow channels which are used only during floods; they may be old, abandoned courses, or initial development of new courses).

Figure A.1 shows some of these features on the upper Yarra River floodplain.



Figure A.1 – Floodplain features of the upper Yarra River (photo: Google Earth)

A3.1.2 Vertical accretion

As floodwaters spread out over the floodplain, they are less able to transport material. This causes the coarser particles (sands and gravels) to drop along the banks, where they sometimes build up natural levees. Finer material is carried further from the channel, where the rate of flow is slow enough to permit silt to be laid down as backswamp deposits. Where depressions occur, floodwaters can be stored to slowly seep away or evaporate, leaving fine clays. Finally, as the floodwaters recede, more material may be deposited on the floodplain as well as in the channel itself (Millar et al. 1965, Morisawa 1968).

A3.2 Floodplain soils

Soil is formed in situ by chemical and physical modification of parent material (rock or sediment), under the influence of groundwater movement, atmospheric agents, organisms and decomposing organic matter of both plant and animal origin. This process may take hundreds or even thousands of years (Costermans 1989).

However, sediment deposition on floodplains enables soils—consisting of loose and often fertile organic material which can immediately carry plant life—to arrive ready-made (Costermans 1989). The establishment of vegetation on the floodplain furthers the growth of floodplains by aiding deposition and preventing erosion (Morisawa 1968).

A3.3 Floodplain vegetation

The array of plants on floodplains includes species that are adapted to conditions ranging from dry, almost terrestrial, conditions through to aquatic conditions, and to various conditions in-between (Roberts et al. 2000). These plants can be grouped under different communities based on factors such as floristic composition, structure and important environmental determinants.

In Victoria, plant communities are described as ecological vegetation classes (EVCs) (Parkes et al. 2003). Each EVC includes a collection of floristic communities (that is, groups based on co-occurring plant species) that occur across a biogeographic range, and, although differing in species, have similar habitat and ecological processes operating.

About 300 EVCs have been described for Victoria, of which a number can be termed floodplain EVCs.

A3.4 Floodplain habitats

Floodplains include both aquatic and terrestrial habitats, making them highly productive and diverse ecosystems. They often support large and diverse populations of plants and animals. For example:

- floodwaters retain and replenish wetlands, supporting the flora and fauna of floodplains and river systems
- following inundation, some floodplains become very important breeding areas, and their proximity to water promotes significant roosting and nesting areas at other times
- floodplains with geomorphic features that retain water (such as billabongs) have several patches where surface water is prolonged, providing habitat for fish and birds
- underlying aquifers provide an alternative water source for deep-rooted species (such as most floodplain trees and some shrubs).

